

**BHARAT INSTITUTE OF ENGINEERING AND TECHNOLOGY**

**(Approved by AICTE Affiliated to SCTE & VT)**

**Sivaram Vihar, Ghatakeswar Hills, Mohada, Berhampur, Odisha**

**Pin- 760002**



**BIET, MOHADA, BERHAMPUR**



**LECTURE NOTES**

**ON**

**CONCRETE TECHNOLOGY**

**CIVIL, 6<sup>TH</sup> SEMESTER**

**PREPARED BY**

**SAUMYA RANJAN PATTANAYAK**

**DEPARTMENT OF CIVIL ENGINEERING**



# CONCRETE TECHNOLOGY



October 2007  
(Corrected & reprinted January 2014)

INDIAN RAILWAYS INSTITUTE OF CIVIL ENGINEERING  
PUNE 411 001

# CONTENTS

<b>Chapter 1</b>	<b>Page No.</b>
<b>GENERAL</b>	
Introduction	1
Developments in Concrete	1
Production of Concrete	3
Material	3
Process	3
Ingredients of Concrete	4
<b>Chapter 2</b>	
<b>CEMENT</b>	
History of cement	6
Composition of modern cement	7
Analysis of Reaction	10
Hydration of various compounds	12
Reaction of Hydration and Gain of Strength	12
Different types of cement	13
1. Ordinary Portland Cement (OPC)	13
2. Rapid Hardening Cement (RHC)	14
3. Sulphate Resistant Cement (SRC)	15
4. Blast furnace slag cement	16
Limitations of slag cement	16
Recommended use of Slag cement	17
5. Portland Pozzolana Cement (PPC)	17
Advantages of Pozzolana cement	18
6. Air entraining cement	18
7. Quick Setting Cement	19

8. Expansive Cement	20
9. High alumina cement	20
Tests of Cement	20
A) Field tests	20
B) Laboratory tests	21
a) Fineness of cement	22
b) Standard Consistency Test	23
c) Setting Time Tests	25
d) Soundness Test	26
e) Strength Test	28
f) Loss on Ignition Test	28
Storage of cement	
Gain of strength in cement	30
Advantages of Blended Cement	31
1) Technical advantages	
2) Environmental advantages	

### **Chapter 3**

#### **AGGREGATE**

Types of Aggregates	33
Properties of aggregates	34
Phases of concrete	38
Sieve Analysis of Aggregates	38
Quality of Aggregates	40
Gap grading of Aggregates	41
Advantages of Gap Grading	42
Bulking of Sand	42

## **Chapter 4**

### **WATER AND ADMIXTURE**

WATER	43
Effect of impurities of water	43
Effect of Sea Water	
ADMIXTURE	44
Categories of Admixtures	45
(1) Water reducing admixtures	45
Mechanism of water reduction	45
(2) Retarding admixtures	46
(3) Air entraining admixtures	46
(4) Accelerating admixtures	47
Factors affecting the performance of Admixture	47
Recommended Methods for better performance	48

## **Chapter 5**

### **PRODUCTION OF CONCRETE**

1) Proportioning	51
2) Mixing	52
Type of batch mixers	
sequence of charging ingredients	
mixing time	52
3) Transportation	54
4) Compaction	57
5) Curing	59
Methods of Curing	60
Important Observations Regarding Curing	61

## **Chapter 6**

### **MIX DESIGN**

Definition of mix design	63
Types of Mix Design	63
Designation of concrete	64
Sampling	65
Cube Casting	66
Cube Testing	66
Importance of Cube Test	65
Statistical interpretation of cube results	67
Target Mean Strength	68
Understanding of Normal Distribution Curve	70
Acceptance Criteria (As per IS-456:2000)	70
Acceptance criteria (As per CBC)	72
Mix Design Example	73

## **Chapter 7**

### **DURABILITY OF CONCRETE**

Mechanism of Corrosion	82
Process of change in pH value	83
Process of Carbonation	85
Permeability Test	87
Good Construction Practices	88
Conclusion	90

## **Chapter 8**

### **HIGH PERFORMANCE CONCRETE**

Role of Mineral Admixtures	91
READY MIX CONCRETE	92

Truck-mounted Drum Mixer	93
Types of Ready Mix Concrete	93
a) Transit mixed concrete	94
b) Shrink mixed concrete	94
c) Central mixed concrete	95
Advantages of RMC	95
SELF COMPACTING CONCRETE	96
Mechanism of Self Compaction	96
Problems in achieving self compaction	97
Advantages of SCC	98
Requirement of Admixtures	99
Use of Mineral Admixtures in SCC	100
Advantages of using fly-ash	100
Tests for Self Compacting Concrete	101
Popularity of SCC in India	104
Cost Comparison	104
VACUUM CONCRETE	104
Technique and Equipments	105
Advantages of vacuum concreting	106
REFERENCES	108

# CHAPTER 1

## GENERAL

### Introduction

Concrete is the most commonly used man made construction material. It has become very popular not only among civil engineers but among common people also. The secret of its popularity lies in the simple fact that except cement, all other ingredients of concrete are commonly available local materials like aggregate and water. Therefore, it is no surprise that the concrete is being used as a construction material from small pavements, to run-ways and express-ways, from small hutments to multi-storied buildings and from small culverts to long multi span bridges.

### Developments in concrete

Popularity of concrete has resulted into many developments and innovations in this field. Earlier we were thinking of M-20 grade concrete only - today we are producing well above M-60. Earlier we were struggling for normal concrete - now we are producing concrete with new characteristics i.e. High Performance Concrete (HPC), Ready Mixed Concrete (RMC) and Self Compacting Concrete (SCC). In the same way, earlier we used 'Ordinary Portland Cement' (OPC), today we are using 'Cementitious' material instead, which is OPC blended with fly-ash, slag and micro silica. Earlier we knew only about the conventional ingredients of cement like cement, aggregate and water, but today we are well conversant of the importance of admixture too.

This much of progress has been possible in the field of concrete because we have accepted concrete as an ideal construction material. But this doesn't mean that concrete can replace steel or any other construction material. In fact it has come on the same platform with other materials and it



is considered as an option before deciding a particular construction material.

There has been a continuous improvement in the method of concrete production called 'process'. Today we have become more aware about selection of materials and their proportioning as well. We have now understood the importance of quality control in 'compaction' and 'curing' of concrete and therefore implemented these in the actual structures too. There has been a marked difference in the concrete quality as a result of this awareness.

There was a time when we used to give importance only to the compressive strength of concrete. But today we know that durability is also an important parameter in addition to compressive strength. In fact, durability is nothing but the long term guarantee for the serviceability of the structure including its compressive strength. The service life of a structure depends upon durability which depends upon various factors such as : water-cement (w/c) ratio, compaction and curing. Water-cement ratio should be kept minimum and compaction and curing should be ensured to the fullest extent so as to reduce the permeability and increase the durability.

A new concept of concrete which has significantly improved the quality of concrete is 'Ready Mix Concrete' (RMC). RMC is manufactured in controlled conditions of batching plants where it has to pass through the strictest quality control. Then it is transported to the destination through truck mixers ensuring the required workability.

Continuing the series of improvements in the quality of concrete, recently we have developed a new category of concrete called 'Self Compacting Concrete' (SCC). This was originally developed in Japan due to shortage of manpower. But its use has proved to be a boon for the construction industry because this has come out as the most modern type of concrete. No vibration is required for the compaction of this concrete and the concrete automatically flows into the

formwork. Since it flows like fluid, it can easily reach every nook and corner of the formwork and the full compaction is ensured automatically. This results into not only the higher compressive strength but drastic increase in durability also. In order to increase the durability of concrete, we have also started the use of blended cement in place of normal OPC. The blended cement is obtained by adding mineral admixtures like fly-ash, slag and silica fumes to OPC. Micro silica or silica fume has a major role to play in the manufacture of High Performance Concrete (HPC). Its fineness is much higher as compared to OPC so that it can penetrate into the micro spaces of the concrete resulting into a highly compact mass with very little permeability. This results into high cube strength as well as improved durability of concrete.

As a result of many developments and improvements in the concrete technology, we have come a long way in production of concrete and 'concrete' has eventually been established as a reliable construction material.

### **Production of concrete**

The production of concrete involves two distinct but equally important activities. One is related to 'material' required for concrete and the other to 'process' involved in its production.

#### **Material**

The activity related to materials involves their

- (1) Selection and
- (2) Proportioning

#### **Process**

The activity related to process involved in production of concrete involves :

- (1) Mixing
- (2) Transportation
- (3) Placement
- (4) Compaction and

## (5) Curing

Out of above activities, more often than not, it is the 'process' which is responsible for quality of the concrete, though the cost of the concrete is mainly governed by the cost of the materials. The selection of materials and their proportioning is usually well taken care of at higher levels but the process is left to the lower levels. The expenditure incurred on materials goes waste if the process is not taken care of. Ignorance and lack of appreciation of good practices are the main reasons for the poor quality of concrete. Therefore, if we are able to control the process, we can obtain far better quality of concrete at no extra expenditure.

## Ingredients of concrete

The basic ingredients of concrete are as given below:

(1) **Cement** - It is the most important and costliest ingredient of concrete. The mix-design of concrete indirectly means optimising the use of cement for obtaining the desired properties of concrete in green as well as hardened state. It affects the overall economy of the structure too. Different types of cements are available for different type of structures and different types of locations. Judicious selection of cement is necessary for the longevity of the structure.

(2) **Aggregate** - The aggregates give volume to the concrete because these occupy maximum space in the total volume of concrete. Efforts should be made to use maximum quantity of aggregates as these increase the volumetric stability of concrete and make the mix-design more economical.

(3) **Water** - It is indispensable because it is required for reaction of hydration. But its use should be restricted to

minimum as possible considering the requirement for chemical reaction with cement and workability only. Any excess water is destined for evaporation, leaving capillary-pores in the concrete. Eventually, strength and durability both will be adversely affected when water is excessive.

**(4) Admixture** - It is an optional ingredient which is used only for some specific purpose. It is used to modify some of the properties of concrete like setting time, workability or surface finishing characteristics etc. But admixture should not be used to compensate for bad quality of concrete instead it should be used as a supplement to good construction practices. Though the newer versions of concrete i.e. HPC, RMC and SCC, the use of admixtures has become indispensable.

All these ingredients are explained in the following chapters in greater details.

■ ■ ■

## CHAPTER 2

# CEMENT

### History of cement

In general, cement is described as a material used to bind the mineral fragments called aggregates. The cement paste acts as glue which makes a cohesive mass with all the aggregates. This bonding is very important as the concrete fails not because of less strength of aggregates but mainly due to failure of bonding.

Production of cement is only a recent development. It was conceived in 1824 by William Aspidin, but it was developed in the form of present day cement by Isaac Charles Johnson in 1845. He produced this modern cement by burning a mixture of chalk, clay and silica up to a temperature of 1400-1450°C. At this temperature, the basic raw materials i.e. lime, clay and silica fuse together forming 'clinkers' in the shape of spherical balls of 3 to 25 mm in diameter. Due to high temperature, approximately 20-30% of the material become liquid and crystallises into spherical balls on cooling.

The cement may be a recent development, but the use of cementing material is quite old. Lime and gypsum were used as early as 2560 BC by the Egyptians in making Great Pyramids. Similarly the Greek and the Romans also used calcined lime stone. The basic raw materials of these cementing materials were the same as of today's cement but the only difference is the temperature up to which these are heated. Prior to production of modern cement, a temperature of 1400-1450°C was not heard of and the ingredients used to be mixed at atmospheric temperature

The cement was produced as a product by combining lime with volcanic ash containing active silica and

aluminium, at normal temperature. This product was known as 'pozzolanic cement' because the volcanic ash used in this was obtained from a village called 'Pozzuoli'.

Present day cement is called 'Hydraulic Cement' by virtue of its property of setting and hardening even under water.

### **Composition of modern cement**

The modern cement is also called 'Ordinary Portland Cement' because after setting it resembles in colour and quality with the 'Portland Stone' quarried in Dorset-UK.

Portland cement primarily consists of

- (1) Calcareous material : Limestone or chalk
- (2) Argillaceous material : Clay/Shale
- (3) Silicious material : Silica

The process of manufacturing of cement essentially involves the following activities:

- a) Proportioning of raw material,
- b) Grinding, intimate mixing and
- c) Burning in a large rotary kiln at 1400-1450°C.

Due to intense heat, 20 to 30 % of material fuses together forming spherical balls known as 'clinkers'. The 'clinker' is only one step short of cement. The cement is obtained by grinding the clinkers up to the desired fineness.

The process of cement production is shown in **Fig-1** as a schematic diagram.



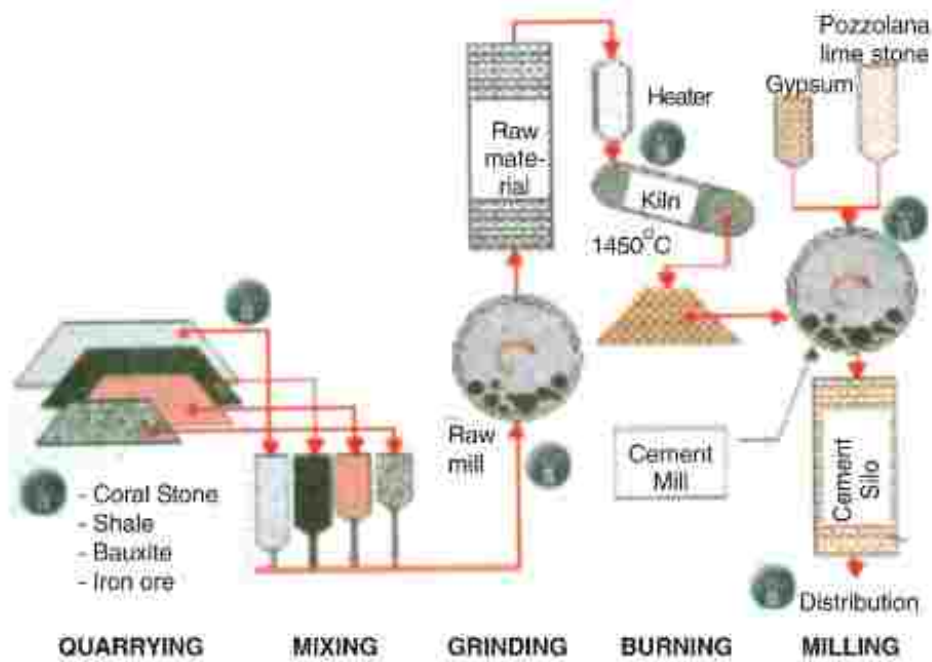

**Fig-1 Process of cement production**

The raw material is always available in the form of oxides in nature. The range of percentages of various oxides which are used in cement is as given in **Table-1**.

**Table-1**

Oxide	Percent
Calcium Oxide (CaO)	59-64%
Silica Oxide (SiO <sub>2</sub> )	19-24%
Aluminium Oxide (Al <sub>2</sub> O <sub>3</sub> )	3-6%
Ferric Oxide (Fe <sub>2</sub> O <sub>3</sub> )	1-4%
Magnesia (MgO)	0.5-4%

When the raw material is heated in the kiln, the oxides get converted into silicates and aluminates in addition to some other compounds. The percentages of all important compounds are as given in **Table-2**.

**Table-2**

Compound	Short form	Chemical Formula	% age
Tri-calcium Silicate	C <sub>3</sub> S	3CaO.SiO <sub>2</sub>	39-50%
Di-calcium Silicate	C <sub>2</sub> S	2CaO.SiO <sub>2</sub>	20-45%
Tri-calcium Aluminate	C <sub>3</sub> A	3CaO.Al <sub>2</sub> O <sub>3</sub>	8-12%
Tetra-calcium Alumino Ferrite	C <sub>4</sub> AF	4CaO.Al <sub>2</sub> O <sub>3</sub> .Fe <sub>2</sub> O <sub>3</sub>	6-10%

Out of the above compounds, the strength of cement is contributed mainly by silicates. Silicates react with water and produce a gel called Calcium Silicate Hydrate or 'C-S-H' gel. This gel is initially weak and porous, but with the passage of time it becomes stronger and less porous. Since it is an exothermic reaction, a lot of heat is generated. The chemical reaction involved in this process is as under.

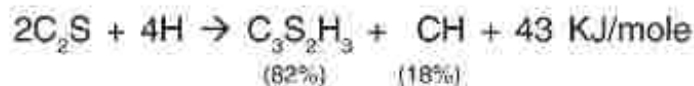
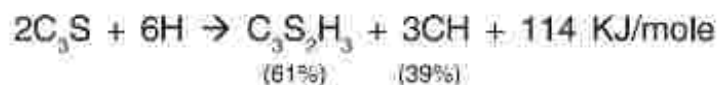

where

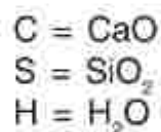

This reaction of cement with water is called 'reaction of hydration'. As a result of this reaction, the silicates produce gel. But Di-calcium Silicate (C<sub>2</sub>S) is considered superior as compared to Tri-calcium Silicate (C<sub>3</sub>S) because it produces superior and large quantity of C-S-H gel. C<sub>3</sub>S produces only 61% of C-S-H gel and 39% CH but C<sub>2</sub>S produces 82% of Calcium Silicate Hydrate C-S-H gel and only 18% of CH. In addition to this, the heat generated is also less in case of Di-calcium Silicate. Less heat means



more durable concrete with less cracks.

Initially when the gel is porous, the pores are completely filled-up with water. About 15% water by weight of cement is required to fill up the gel pores and it is called 'gel water'. In addition to this 23% extra water is required for continuing the chemical reaction which is called 'bound water'. Therefore, theoretically speaking, the total requirement of water should not exceed 38%.

Any extra water causes capillary formation in the concrete which increase the permeability of concrete. If only 38% water is added to the concrete, no extra water will be available for capillary formation and therefore concrete will be more compact, stronger and more durable.

The extent of reaction of cement with water is called 'degree of hydration'. Since the reaction is associated with evolution of heat, the degree of hydration can indirectly be estimated measured by measuring the heat evolved during the reaction. Approximately 50% of the total heat evolution occurs during the first 3 days of hydration and a continuous record of liberation of heat during this period is a very useful indicator for estimation of strength gain.

In the total volume of cement paste, about 50-60% volume is occupied by C-S-H gel, 20-25% by  $\text{Ca(OH)}_2$  and the rest by water, pores etc.

### **Analysis of Reaction**

A schematic diagram showing the cement compounds and reaction with water is as shown in **Fig.- 2**.

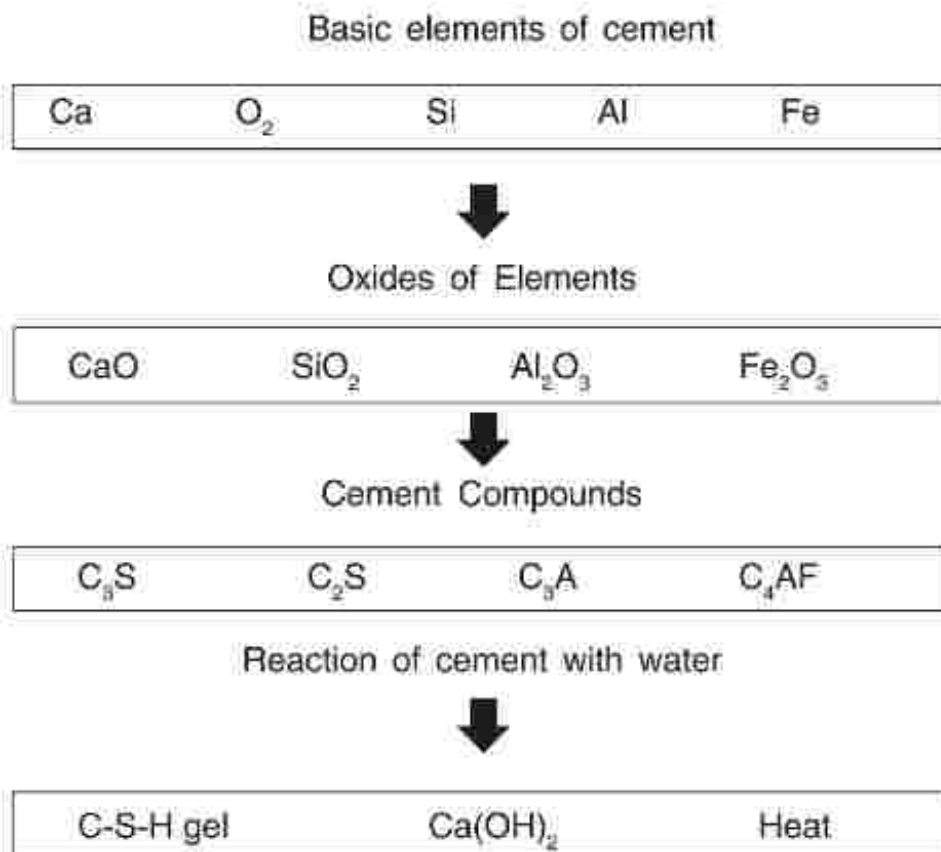

**Fig-2 Reaction of cement with water**

Strength of cement is mainly contributed by silicates i.e.  $C_3S$  and  $C_2S$ , whereas  $C_3A$  is responsible for setting. In the order of reaction with water,  $C_3A$  is the first to react with it and imparts setting to the cement paste. Strength contribution by  $C_3A$  is negligible and therefore can very well be neglected. In the category of silicates,  $C_3S$  is quicker in reacting with water as compared to  $C_2S$ . Therefore the initial strength up to 7 days is mainly given by  $C_3S$ . After 7 days when most of  $C_3S$  has already exhausted,  $C_2S$  also start reacting with water. The strength between 7 and 28 days is contributed mainly by  $C_2S$  and a part is contributed by  $C_3S$  too.

## Hydration of various compounds

### 1) Hydration of Silicates

Since the heat of hydration is proportional to the rate of hydration reaction, initially most of the heat is generated by  $C_3S$ . As described in earlier paras, although the products of reaction are same in both the cases, i.e. C-S-H gel and  $Ca(OH)_2$ , yet quality wise,  $C_2S$  is considered superior to  $C_3S$  because it requires less water for reaction and produces more C-S-H, less  $Ca(OH)_2$  and less heat. All the four parameters are favourable for good quality of concrete as compared to  $C_3S$ . The  $C_3S$  require 24% water by weight of cement whereas  $C_2S$  requires only 21% water for complete hydration. In addition to this, the density and the quality of gel formed by  $C_2S$  is also superior. Therefore higher percentage of  $C_2S$  is desirable in cement

### 2) Hydration of $C_3A$

$C_3A$  reacts very fast with water forming a compound  $C_3AH_6$  which triggers flash set in the cement. Since it is not desirable that cement should set immediately, the quantity of  $C_3A$  in the cement has to be controlled. For this purpose, gypsum is generally added at the time of grinding of clinkers. Hydrated calcium aluminate ( $C_3AH_6$ ) doesn't contribute anything to the strength of cement.

### 3) Hydration of $C_4AF$

$C_4AF$  is a minor constituent of cement which reacts with water and produce  $C_3FH_6$  or hydrated calcium ferrite. Its volume is insignificant and it doesn't contribute to strength.

## Reaction of Hydration and Gain of Strength

The major portion of the strength of cement is achieved during first three weeks after casting, however the process continues forever. It has been found from the experimental studies that the full strength potential of cement is never achieved because the hydration process never gets

completed in reality. In fact, after initial reaction with cement particles, the water is not readily accessible to some of the particles of  $C_3S$  &  $C_2S$  which get surrounded by a layer of already hydrated silicates. These hydrated silicates are relatively impervious to water and therefore come in the way of some particles of cement and renders further reaction slow. It is very much possible that even less reactive  $C_2S$  crystals present on the surface of a cement grain may get hydrated first and a more reactive  $C_3S$  crystals buried in the interiors of a cement grain may hydrate late or may not get hydrated at all.

Therefore, in practice, the full strength potential of cement is never utilised, and therefore the water requirement will also be proportionately less than 38% for the reaction. But in most of the cases, the requirement of water is guided by the requirement of workability and not by the chemical reaction.

### **Different types of cement**

Same type of cement may not be suitable for different locations and climatic conditions. Therefore various types of cement have been developed as per the actual requirements. The necessary changes have been achieved by different methods like :

- (a) Changing oxide composition
- (b) Changing fineness
- (c) Using additives or mineral mixtures like slag, fly-ash or silica fumes etc.

The various types of cements generally used in various locations are as given below:

#### **1. Ordinary Portland Cement (OPC)**

OPC is the most commonly produced and used cement. The name 'Portland' was derived from lime stone called 'Portland stone' quarried in Dorset-UK, due to its resemblance with the set cement.

In OPC category, we have three grades of cement available in Indian market.

- (a) Grade 33
- (b) Grade 43
- (c) Grade 53

## 2. Rapid Hardening Cement (RHC)

It is also called 'Early Strength Cement' because its 3 days strength is almost equal to 7 days strength of OPC. It is different from quick setting cement which only sets quickly whereas in RHC, strength development is very fast. This is because of following reasons:

- (1) Higher fineness of cement. The specific surface of this cement is increased to  $320 \text{ m}^2/\text{kg}$  as compared to  $225 \text{ m}^2/\text{kg}$  for OPC.
- (2) Higher quantity of  $\text{C}_3\text{S}$  in cement as compared to  $\text{C}_2\text{S}$ .  $\text{C}_3\text{S}$  is more reactive in comparison to  $\text{C}_2\text{S}$ .

As a result of these changes, the rate of reaction in the early period is considerably increased and so is the heat generated. Therefore, this cement should be used only where the early strength requirement is there. At the same time it should not be recommended where surface/volume ratio is less and the large heat that will be liberated, may not be dissipated effectively. If it is not ensured then there are chances of temperature cracks.

This cement is recommended :

- (1) In pre-fabricated construction
- (2) When the form work is to be removed early
- (3) In road repair works
- (4) In cold weather where heat generation will be helpful in preventing freezing.

### 3. Sulphate Resistant Cement (SRC)

The normal OPC is susceptible to sulphate attack – particularly magnesium sulphate. The sulphate present in the soil or surrounding environment reacts with free  $\text{Ca(OH)}_2$  available in the concrete and  $\text{CaSO}_4$  is formed. There is no dearth of free  $\text{Ca(OH)}_2$  as it is available in abundance in the set cement. The  $\text{CaSO}_4$  thus produced reacts with hydrate of calcium aluminate and form an expansive compound called calcium sulpho-aluminate which causes expansion and cracks in the set cement. Sulphate attack is further accelerated if it is accompanied by alternate wetting and drying also, which normally takes place in marine structures of the tidal zone.

The cement can be made sulphate resistant if quantities of  $\text{C}_3\text{A}$  and  $\text{C}_4\text{AF}$  are controlled as given below :

$$\begin{aligned} \text{C}_3\text{A} &< 5\% \text{ (Normally it is 8-12\% in OPC) and} \\ 3 \text{ C}_3\text{A} + \text{C}_4\text{AF} &< 25\% \end{aligned}$$

While controlling the quantities of  $\text{C}_3\text{A}$  and  $\text{C}_4\text{AF}$ , a precaution is to be taken when chloride attack is also perceived in addition to sulphate attack. In this situation, the quantity of  $\text{C}_3\text{A}$  should be limited to 5-8%. Similarly when only chloride attack is there and no sulphate attack, then sulphate resistant cement (SRC) should never be used.

The quantity of  $\text{C}_3\text{A}$  in OPC can be controlled simply by blending with slag cement.

SRC is recommended in

- (1) Marine condition where both sulphate and chloride attacks are there
- (2) Construction of sewage treatment plants
- (3) Foundations and basement in soil having sulphate attack.
- (4) Chemical factories

#### **4. Blast furnace slag cement**

This cement is also known as 'ground granulated blast furnace slag (GGBFS). It is produced by blending OPC clinkers with blast furnace slag in suitable proportion (generally 25-65%) and grinding together. A small quantity of gypsum is also added which acts as a retarder. The slag can be separately grinded and mixed with OPC in the mixer during concreting also. But in the conventional drum mixers, it is difficult to achieve proper mixing.

The slag is a waste product in the manufacture of steel from open hearth blast furnace. Earlier this waste was thrown outside the plants and huge stacks of slag were lying unused creating disposal problem. It was later found that the constituents of slag were similar to that of cement and the so called 'waste product' was rechristened as 'by-product'. Its extensive use now has resulted in saving of enormous energy and raw mineral in addition to prevention of pollution.

#### **Limitations of slag cement**

The only word of caution while using this cement is that the early strength is less as compared to OPC. Therefore the form-work removal should be adjusted accordingly. The early strength of blended cement is due to OPC fraction only and the slag fraction joins in strength contribution later on.

Earlier there was a considerable resistance and suspicion in the minds of the users in using the slag cement mainly because the good quality of slag was not available. In fact earlier the thrown out air-cooled slag was being used which is not considered good quality for concrete. Instead of air cooling if the slag is rapidly cooled by pouring water over it, then the process of crystallisation is prevented and it solidifies as granules. This slag is ideal for cement. That is the reason why it is now called 'granulated slag'.

Physical properties of slag cement are similar to those of OPC in terms of fineness, setting time, soundness



and strength etc, but the initial reaction with water is slower due to which the heat of hydration is low. It is a better resistant to sulphate, alkali and acid also.

### **Recommended use of Slag cement**

- (a) In sewage disposal works
- (b) In water treatment plants
- (c) Where low heat cement is required
- (d) Where high chloride and sulphate attack is there

### **5. Portland Pozzolana Cement (PPC)**

'Pozzolana' essentially means a silicious material having no cementing properties in itself. But in finely divided form it reacts with  $\text{Ca(OH)}_2$  in presence of water at ordinary temperature and forms compounds possessing cementing properties. In this process  $\text{Ca(OH)}_2$  is also utilised which otherwise is destined to leaching out of concrete leaving a porous and weaker concrete.

The chemical reaction which takes place is as given below:

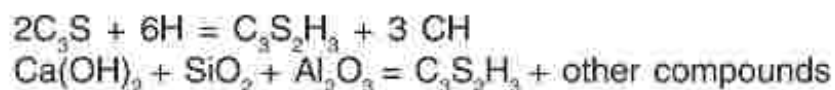

Generally fly-ash, shale, volcanic ash, opaline, diatomaceous earth etc. are used as Pozzolanas. It is easier to grind together OPC clinkers with pozzolana than mixing the pozzolana afterwards at the time of mixing. Mixing afterwards is difficult because of Pozzolana being finer than cement. Fineness of Pozzolana is  $300 \text{ m}^2/\text{kg}$  as compared to  $225 \text{ m}^2/\text{kg}$  for OPC.

Fly-ash is a waste product of thermal plants which is collected by electro-statically precipitating the exhaust fumes of coal-fired power stations. The use of fly-ash is an eco-friendly process as precipitation of fly-ash reduces the pollution. The quality of fly ash is tested as per IS :



3812:1981. The code specifies that percentage of silica plus alumina should be at least 70% and maximum loss on ignition should be maximum 12%. Generally much better quality is available from power plants as compared to the codal specifications. The obvious advantage of using PPC is that impermeable and denser concrete is produced by blending OPC with fly-ash.

The early strength of PPC is contributed by OPC fraction and Pozzolana also starts contributing after some time. This early strength should normally be not less than 22 MPa in 7 days and not less than 31 MPa in 28 days. Other properties of PPC like soundness, setting time etc. are same as OPC.

#### **Advantages of Pozzolana cement**

1. Less heat of hydration
2. Reduced leaching of  $\text{Ca(OH)}_2$  as it is utilised in reaction with pozzolana.
3. It can be used at almost all the places where OPC is used.

#### **6. Air entraining cement**

Air is entrained in the concrete in the form of bubbles which modify the properties of fresh concrete i.e. workability, segregation, bleeding and finishing characteristics. It also modifies the properties of hardened concrete i.e. resistance to frost action and permeability. Air bubbles acts as flexible ball bearings so that friction between the various ingredients of concrete is reduced and workability is automatically improved without additional water. The desirable air content is 3-6%. The various air entraining agents generally used are :

- (a) Alkali salts of wood resin
- (b) Synthetic detergents
- (c) Calcium ligno-sulphate
- (d) Aluminium powder, animal fats etc.

These are also available under commercial names such as vinsol resin, airon, darex, teepol etc. Just for clarity, entrained air is different from entrapped air. The difference between them is given in the **Table-3**.

**Table-3**

**Difference between entrained and entrapped air**

<b>Entrained Air</b>	<b>Entrapped Air</b>
1. Entrained air is intentional and it is distributed evenly.	1. Entrapped air is due to insufficient compaction and unevenly distributed.
2. The size of bubbles in entrained air is very small ranging from $5\mu$ to $80\mu$ .	2. The size of entrapped air pockets may vary from $10\mu$ to $1000\mu$ .
3. The shape is nearly spherical.	3. Entrapped air may be of any shape as it follows the contours of aggregate surface.
4. It is a desirable process.	4. It is an undesirable inclusion.

Air entraining cement is not very popular in India and it is not covered by any IS Code. But in 1950s, it had been used in some of the very big dams in India like Hirakud dam, Koyna dam and Rihand dam. For these works the air entraining agents like Vinsol and Darex were imported from the USA.

**7. Quick Setting Cement**

The setting time of ordinary cement is very less if gypsum is not added at the clinkering stage. Therefore when quick setting cement is required, the gypsum is deliberately added in less quantity or not added at all. This type of cement is useful in flowing water and some typical grouting operations.

## 8. Expansive Cement

Generally there is a tendency of shrinkage in green concrete due to drying. Shrinkage is associated with reduction in volume which may cause cracking in the concrete. If sulpho-aluminate is added to the cement, the expansion due to sulpho-aluminate will counteract the shrinkage of concrete. This cement is used for repair works where the change in volume is not desirable.

## 9. High alumina cement

This cement has a very high rate of strength development. In this type of cement, up to 80% of total strength is achieved in one day only. Lime and bauxite are used as raw material for producing this cement. Because of large proportion of bauxite, this cement is called high alumina cement. The rate of heat generation is also proportionately high i.e. 2.5 to 3 times of rapid hardening cement. The form work should be stripped-off as early as possible to prevent built-up of high temperature.

This cement is resistant to sulphate attack due to inert quality of alumina gel and absence of  $\text{Ca(OH)}_2$ .

### Tests of Cement

Normally two types of cement tests are conducted as given below :

- A) Field tests
- B) Laboratory tests

#### A) Field Tests

There are some field tests which give some basic idea about the quality of the cement without elaborate facility of laboratory in the field. These tests are as given under:

##### (a) Date of manufacture

It is important because the strength reduces with

age. Date of manufacture should be seen on the bag. A rough indication of reduction in strength with age is given in **Table-4**.

**Table-4**

<b>Period of Storage</b>	<b>Strength w.r.t. 28 days strength</b>
Fresh	100%
3 months	80%
6 months	70%
12 months	60%
24 months	50%

(b) Open the bag and see that lumps should not be present in the bag. It will ensure that no setting has taken place.

(c) Thrust your hand into the cement bag and it should give cool feeling. It indicates that no hydration reaction is taking place in the bag.

(d) Take a pinch of cement between the fingers. It should give smooth feeling.

(e) Throw handful of cement on water. It should float initially before finally settling.

(f) Take 100 g of cement and make a stiff paste. Prepare a cake with sharp edges and put on the glass plate. Immerse this plate in water. Observe that the shape shouldn't get disturbed while settling. It should be able to set and attain strength. Cement is capable of setting under water also and that is why it is also called 'Hydraulic Cement'.

## **B) Laboratory tests**

Although most of the tests are conducted in the laboratories of producers and a certificate is also being provided by the supplier along with the supply, yet some of the tests are also conducted by the user in their own

laboratories for confirmation and also to assess the deterioration of strength potential during transit. The various tests which are generally conducted on cement are as given under :

#### **a) Fineness of cement**

Fineness of cement determines the rate of hydration reaction. Finer cement reacts faster with water and the rate of development of strength and corresponding heat of hydration is higher. IS Codes prescribe only the values of minimum fineness which are required for different types of cements.

Fineness can be determined either by specific surface using air permeability test or it can be determined by actual sieving. As per IS 4031 (Part II) - 1999 & IS : 4031 (Part I)-1996. The limits of residue on sieve should be as given under:

For OPC, < 10%

For PPC, HSFC & SGC, < 5%

As per IS 4031 (Part II) - 1999 the minimum specific surface for OPC should be 225 m<sup>2</sup>/kg and for PPC, 320 m<sup>2</sup>/kg and SGC it should be 375 m<sup>2</sup>/kg.

#### **Effect of fineness of cement**

(1) Due to increased fineness, the surface area of cement increases and reaction with water becomes quicker. Therefore the gain of strength also becomes faster but the ultimate strength remains unaffected. This will be clear by observing the trend of relation between specific surface and strength as shown in **Fig-3**.

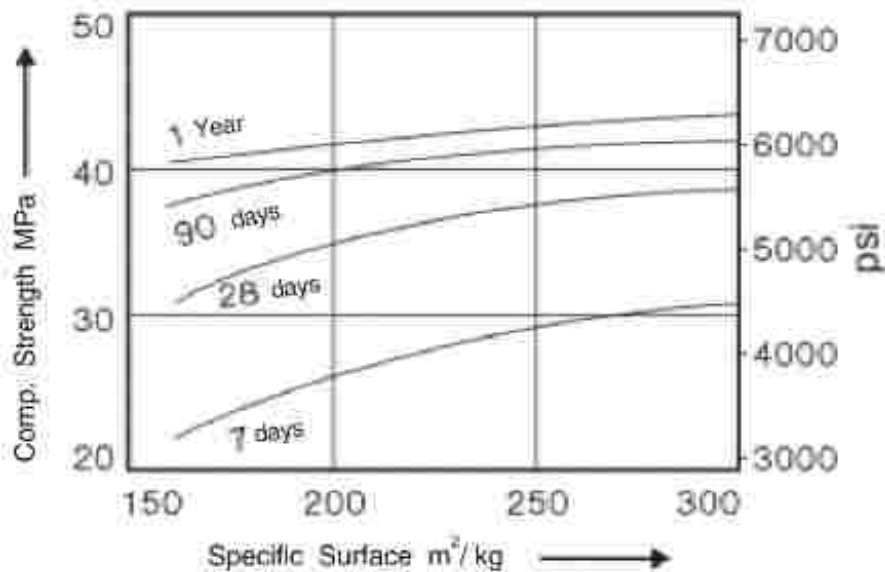

**Fig - 3 Relation between specific surface and strength**

From this figure it is evident that 7 days or 28 days strength may be higher for finer cement but 1 year strength is almost same even for higher fineness. In fact it will be exactly same if we compare the ultimate strength at infinity.

(2) Chance of bleeding reduces in the concrete if finer cement is used.

(3) Shrinkage and cracking in the concrete increases with fineness.

Note: 'Bleeding' is the separation of water from cement paste and 'segregation' means separation of aggregates from the concrete.

### **b) Standard Consistency Test**

This test in itself doesn't give any quality parameter of cement but it ascertains the volume of water which is to be added for other tests like initial setting time, final setting time, soundness and strength etc. 'Vicat's Apparatus' is used for this test as shown in the **Fig-4**.

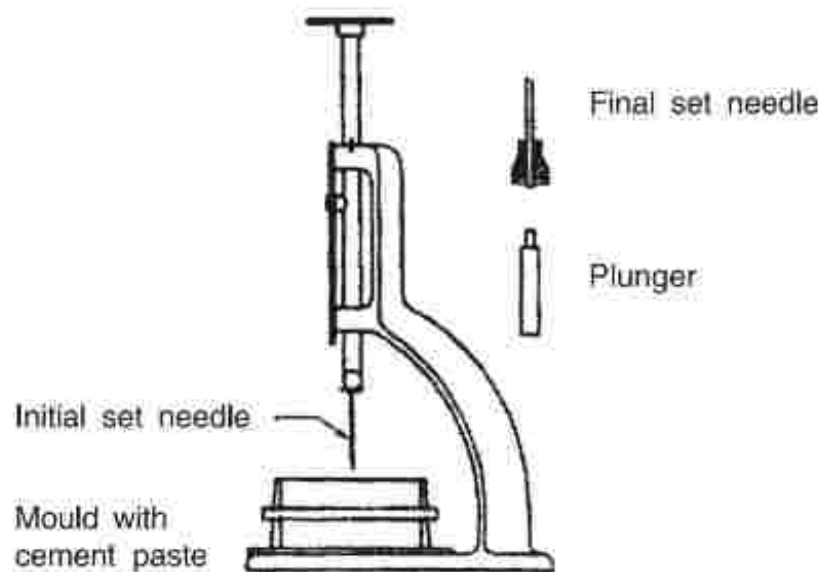

**Fig - 4 Vicat's Apparatus**

### **Procedure**

About 500 g of cement is taken and paste is made by adding about 24% water by weight of cement. Cement and water are correctly measured before adding because the quantity of water needs to be adjusted to achieve normal consistency of paste.

Within 3 to 5 minutes of adding water at  $27 \pm 2^\circ\text{C}$ , the paste is filled in the mould of 80 mm dia and 40 mm height. After keeping the mould in position, the Vicat's plunger of 10 mm dia and 50 mm height is fitted to the apparatus and it is kept in touching position with top of the paste in the mould. Then plunger is quickly released and its penetration in the paste is recorded. The quantity of water is adjusted in such a manner that the penetration achieved becomes 33-35 mm.

The percentage of water by weight of cement which causes the penetration of 33-35 mm is called 'Standard Consistency' and it is designated by 'P'. This value is useful in standardization of other tests of cement as shown in **Table-5**.



**Table-5**

S.N.	Test	Addition of water
1.	IST & FST	85% of P
2.	Soundness test	78% of P
3.	Strength test	(P/4)+3 %

**c) Setting Time Tests**

Setting time means the time required for stiffening of cement paste to a defined consistency. There are two important limits on time scale which are important for setting of cement :

- (i) Initial setting time
- (ii) Final setting time.

**(i) Initial setting time**

By definition it is the time from addition of water to a time when the paste starts losing its plasticity. The test is conducted using 'Vicat's apparatus'. A needle of size 1 mm<sup>2</sup> is used for measuring the penetration. 500 g of cement is taken and water equal to 0.85 'P' is added to make paste and the test is conducted at 27±2°C. The needle is lowered till it touches the top surface of paste in the mould and then tightened. The needle is then quickly released and penetration is recorded. Initially it may go down and touch the bottom. As the time passes and the paste stiffens, the penetration of the needle will reduce. The test is repeated till such time when the needle is 5 mm (+0.5 mm) above bottom of mould. This time is called 'Initial setting time'. When the test is repeated, the mould should be slightly displaced so that the needle doesn't penetrate at the same location.

**(ii) Final setting time**

It is the time from addition of water to the time when paste completely loses its plasticity. The earlier test is continued but with the changed needle. This needle has



special attachment such that when the penetration is more than 0.5 mm, there will be two impressions on cement paste, one of main needle and second of a circular cutting edge. But there will be only one impression of main needle when penetration is less than 0.5 mm.

Therefore 'final setting time' is the time from addition of water to the time when the penetration is just less than 0.5 mm or when the circular cutting edge fails to make an impression on the cement paste.

#### **d) Soundness Test**

This test is conducted to find out the presence of excess unburnt lime in the cement. Due to this lime, cracks may develop in the set cement because of increase in volume. When excess lime is present in the raw material, there is a possibility that entire lime may not combine with acidic oxides at the time of burning in the kiln and some free lime may be left in the cement. This free or hard burnt lime hydrates very slowly and some of it will hydrate only when the cement has already set. Due to this delayed hydration of lime, expansion will take place in the set cement as the hydrated lime or  $\text{Ca}(\text{OH})_2$  occupies more volume as compared to quick lime or  $\text{CaO}$ . Since no space is available for expansion after setting of cement, this expansion causes cracks in the set cement which is called 'unsoundness' of cement. In fact there may be three main reasons for this excess free lime in the cement as given below :

- (i) Inadequate burning of raw material
- (ii) Insufficient grinding of raw material
- (iii) Insufficient mixing of raw material

The test to find out the expansion due to free lime will indicate the presence of free lime and limit of expansion will be a guiding factor for the soundness of cement. The cement will be considered 'sound' if the expansion is within the permissible limits otherwise it will indicate 'unsoundness'. The expansion is measured using 'Le Chatelier Apparatus' and it

should be limited to 10 mm for all cements except for Special Grade Cement (SGC). For SGC this limit is 5 mm.

### Test Procedure for soundness test

Step 1: Cement paste with water equal to  $0.78 \times P$  (Standard consistency) by weight of cement is prepared and filled up in the mould. The mould is 30 mm in dia, 30 mm in height and splitted along height. It is provided with a 165 mm length indicator for magnification of expansion as shown in **Fig-5**. This is called 'Split Brass Cylinder'. After filling the mould, glass plates are put at top as well as at bottom. Then the assembly is put in water at a temp. of 27-32°C. After 24 hours it is taken out and distance between pointers is recorded at the extreme end. Let it be 'x'. Till now, the free lime present in the cement has not contributed any expansion.



**Fig - 5 Split Brass Cylinder**

Step 2: Assembly is again submerged in water and water is heated up to boiling point in about 30 minutes. It is kept in boiling water for 3 hours. Again distance between pointers is recorded at the extreme end. Let it be 'y' which will be obviously more than 'x' because now expansion due to free lime has occurred due to boiling water. Therefore,

$$\text{Net expansion due to free lime} = y - x$$

The above test is suitable for detection of expansion due to free lime only though it can be due to magnesia also. When free lime and magnesia both are present, a test called 'Autoclave Test' is recommended which is explained below :

### **Autoclave Test**

A cement specimen of 25 x 25 mm<sup>2</sup> section and 250 mm length is prepared and cured in humid air for 24 hours. It is then placed in autoclave which is a high pressure steam-boiler. The temperature is raised to  $215.7 \pm 1.7^{\circ}\text{C}$  and steam pressure increased to  $2.1 \pm 0.01$  MPa in approximately 60 to 75 minutes and maintained for 3 hrs. The autoclave is then cooled and the length of the specimen is measured again.

The expansion of bar should not be more than 0.8 %.

### **e) Strength Test**

The test is conducted with paste of cement and sand in the ratio of 1:3. Sand is used to prevent excessive shrinkage. The paste is prepared with 200 g cement, 600 g sand and  $(P/4 + 3.0)\%$  of combined weight of cement and sand. The paste is mixed for 3-4 minutes and filled-up in cube moulds of 7.06 cm sides. The moulds are vibrated on a standard vibrating table and then kept for 24 hours at  $27 \pm 2^{\circ}\text{C}$ , at 90% relative humidity. Cubes are then taken out and submerged in clean fresh water at  $27 \pm 2^{\circ}\text{C}$  and tested after 1,3,7 and 28 days depending upon type of cement. 3 cubes constitutes one sample and an average of 3 cubes is taken as compressive strength. Material for each set of three cubes is mixed separately.

### **f) Loss on Ignition Test**

1.0 g of cement is taken on platinum crucible and heated up to a temperature of 900-1000°C for 15 minutes. The loss due to evaporation of moisture and  $\text{CO}_2$  causes weight loss which should not be more than 5% for all cements. Moisture and  $\text{CO}_2$  are normally present in combination with free lime and magnesia.

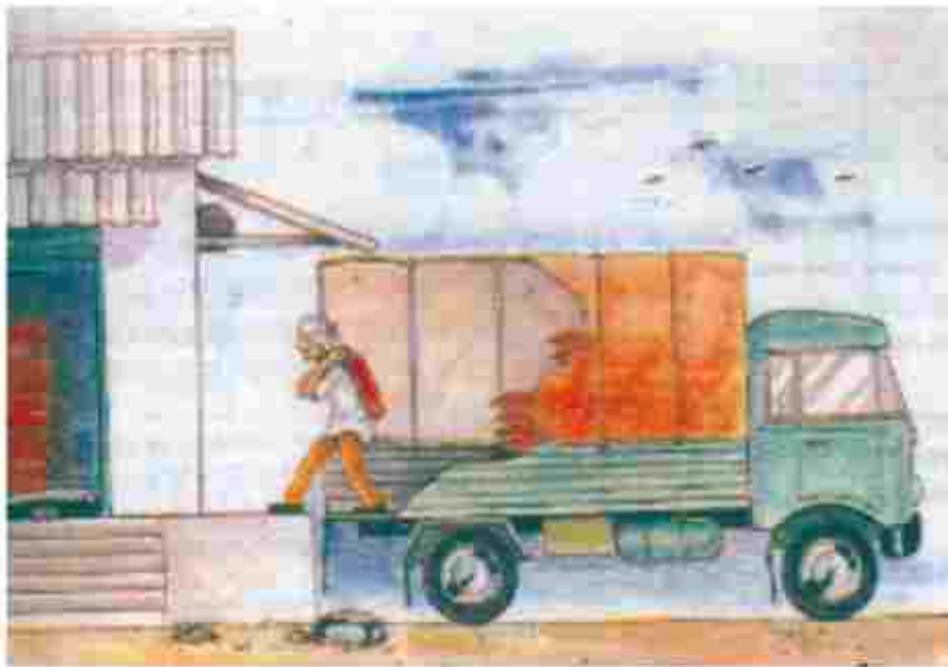
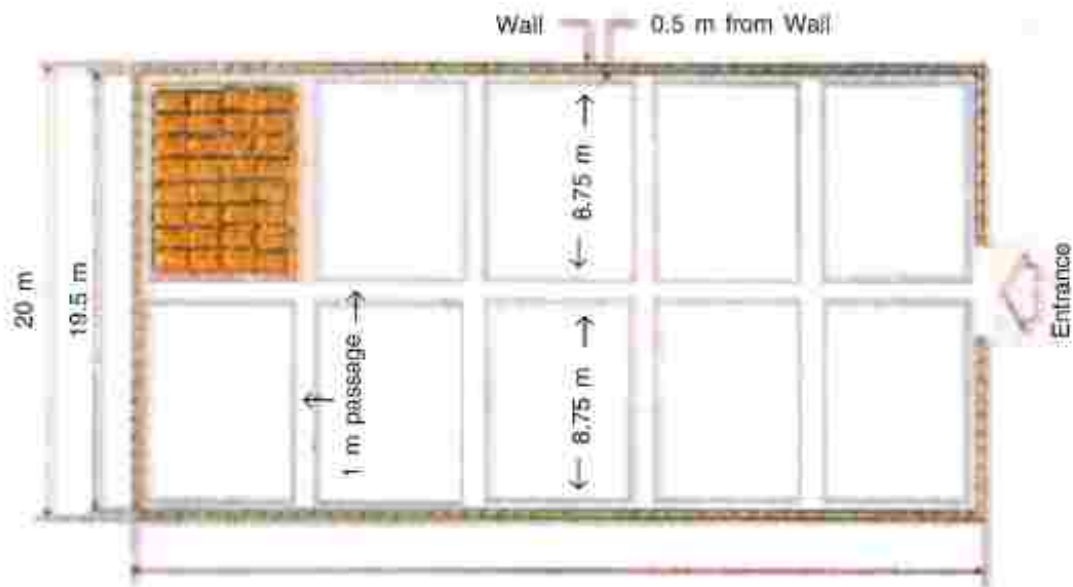

**Fig - 6 Store Godown**

### **Storage of cement**

Since cement is hygroscopic in nature, it loses strength with time depending upon its exposure to moisture. Therefore in order to minimize the loss of strength, the following precautions should be taken while storing the cement in godown.

- (1) Godown should be air tight and moisture proof and above the ground level as shown in **Fig-6**.
- (2) Bags should be stacked on raised platform
- (3) Different stacks should be made for different cement company, date of manufacture, type and grade of cement. In addition identification tags should be displayed on each stack showing all above details.
- (4) There should be a clearance of about 0.6 m between adjacent stacks and also outer walls and the stacks as shown in **Fig-7**.
- (5) Normally not more than 7-8 bags should be stacked vertically. Up to 15 bags can be permitted temporarily.



**Fig - 7 Cement storage**

Efforts should be made to remove additional bags as early as possible.

- (6) During rainy season, the stacks should be covered with 700 gauge polythene sheets.
- (7) For general purpose 'First in - First out' policy should be adopted.

### **Gain of strength in cement**

Initially the rate of gain of strength in the cement is very high but it reduces with time. However, the process of strength gain continues forever. The strength gain is faster in the beginning mainly because of the following reasons :

- (1) Prompt response of more active constituents
- (2) Rapid hydration of finer particles of the cement
- (3) Ready availability of a lot of free water

As outer layers start setting, the availability of water reduces for the inner particles and the rate of gain of strength decreases.



## **Advantages of Blended Cement**

Blended cement is obtained by mixing OPC with mineral admixtures or additives like fly-ash, slag or silica fumes. Blended cements are now being considered superior as compared to conventional OPC category of cements. The advantages of using the blended cement can broadly be divided in two categories i.e.

- 1) Technical advantages and
- 2) Environmental advantages

### **1) Technical advantages**

- (a) It reduces water demand and therefore w/c ratio can be reduced.
- (b) It improves workability for the same water content.
- (c) The blended cements are finer as compared to OPC therefore the permeability of concrete is less. This results into improved durability.

### **2) Environmental advantages**

- (a) Energy saving : Blended cements are obtained by adding mineral admixtures with OPC. The energy, which would have otherwise been utilised for production of OPC, is thus saved. This saving is to the tune of 0.8 to 1.2 MWH/ton of cement.
- (b) Conservation of natural resources : The used mineral admixtures are the waste products of thermal and steel plants. By using these products, we are conserving the precious minerals like lime stone, clay and silica etc.
- (c) Pollution control : By reducing the production of cement pollution is also controlled as cement is an energy intensive product. It has been estimated that 7% of total present pollution is only due to cement production which can proportionately be reduced if more blended cement is used.

Note: Presently in India about 30% of the total production is blended cement. This figure is likely to increase sharply with the increase in awareness of use of blended cement. In UK & USA, the usage of blended cement is nearly 90% of the total production. Durability problem can be effectively tackled by reducing the permeability of the concrete using blended cement. Durability has been identified as the potential threat for concrete structures.

■ ■ ■

## CHAPTER 3

# AGGREGATE

Aggregates give body to the concrete. They also reduce shrinkage and effect overall economy. Since aggregate is cheaper than cement, it is economical to put as much aggregates as practically possible. Not only the use of more volume of aggregate in concrete is economical, it also provides higher volume stability to the concrete. Generally they occupy 60-70% of the total volume of concrete. At the same time the aggregates should be strong because the weak aggregates can't make strong concrete and they may limit the strength of concrete. Therefore the selection of aggregate becomes very vital.

Earlier aggregates were viewed as an inert ingredient of concrete but now their importance has been understood and these are no more considered inert. Their physical, chemical as well as thermal properties greatly influence the properties of concrete.

### Types of Aggregates

In terms of size, there are two broad categories of aggregate as given below :

1. Fine Aggregate – passing 4.75 mm sieve
2. Coarse Aggregate – retained over 4.75 mm sieve

Within a particular category also, aggregates could have representation of all standard sizes as per relevant IS - codes. The different sizes of the aggregates are mixed for making concrete assuming that voids created by the larger size will be filled up by the next immediate lower size. Again some voids would be created, which would accommodate the next lower size. This assumption holds good from coarse aggregate to fine aggregate and then finally up to cement



paste. At the end we should get a compact mass of concrete with minimum or no voids.

## **Properties of aggregates**

The properties of aggregates can be broadly be categorised as :

### **1. Inherited properties**

These properties are inherited by the aggregate from the parent rock. These are as given below :

- (i) Chemical and mineral composition
- (ii) Specific gravity
- (iii) Hardness
- (iv) Strength
- (v) Colour etc.

### **2. Acquired properties**

These properties are acquired by aggregates in the process of crushing. These properties are :

- (i) Aggregate shape
- (ii) Aggregate size
- (iii) Surface texture
- (iv) Water absorption

If we closely observe the above two categories of properties, we can easily infer that not only the source or parent rock is important in influencing the properties of aggregate, but the properties which have been acquired by the aggregate is also equally important. All the acquired properties greatly influence the properties of fresh as well as hardened concrete. Therefore all the acquired properties need to be closely studied before the aggregate is selected for concrete. These are elaborated as under :

### **1. Aggregate Shape**

The shape acquired by aggregate can't be defined by any regular geometrical shape. It can approximately be defined by the words given as under :

- (i) Rounded
- (ii) Angular
- (iii) Elongated
- (iv) Flaky
- (v) Irregular

The shape can also be defined by a mathematical entity called Angularity no. It measures the percentage of voids in excess of 33%. This 33% represents the percentage of voids in most rounded gravels.

Mathematically

$$\text{Angularity No.} = 67 - (\text{Bulk Density/Sp. Gr.}) \times 100$$

Here 67 represents percentage of solid in total volume of the most rounded gravel. It has been found that if gravels are most angular, the percentage of solid in total volume will reduce to 56%. Therefore angularity no. will vary from 0 to 11 depending upon roundness. Higher the angularity no., more angular will be the aggregate.

Flaky aggregates have thickness less than 0.6 times mean sieve size to which particles belong. Similarly elongated aggregate have length dimension more than 1.8 times mean sieve size.

The shape of aggregate is influenced by the type of crusher as well as its reduction ratio.

This may be a question of debate which type of aggregate should be used for concrete. According to the field experience, the rounded aggregates are preferred for the low grade of concrete where w/c ratio is more than 0.4, but angular aggregates are preferred for higher grade of concrete and where the requirement of flexure strength and interlocking is higher.

## **2. Aggregate size**

Larger size of aggregate is preferred in concrete because of the following reasons :

- (i) It reduces the cement requirement

- (ii) It reduces the water requirement
- (iii) It reduces shrinkage of concrete

But practically, there are a no. of factors which limit the use of higher size aggregates in the concrete. The maximum size of aggregate (MSA) which can be used is guided by the factors given below :

- (a) Thickness of section  
MSA should not be greater than thickness of section/4
- (b) Spacing of Reinforcement  
MSA should not be greater than 5 mm less than spacing of steel
- (c) Clear Cover  
MSA should not be greater than 5 mm less than cover provided

For Plain Concrete called 'Plum Concrete', even rubbles of size up to 160 mm have been used. For RCC works, MSA of 20 mm is generally used. For PSC works, this size should be further reduced.

### **3. Surface texture**

It is the surface quality of aggregate in terms of roughness. Texture of aggregate depends upon its hardness, grain size, pore structure and degree to which it has been polished by the external forces like wind and water. There can be two types of texture for aggregate as given below :

- (a) Smooth texture
- (b) Rough texture

#### **(a) Smooth texture**

Generally hard, dense and fine grained aggregates are smooth textured. The surface area is less due to less irregularities, therefore these require less quantity of paste for lubrication. But as smoothness increases, the bonding area with matrix also reduces. Therefore, although more compressive strength may be achieved due to less

requirement of water, yet the flexure strength decreases due to poor bonding and interlocking.

(b) Rough texture

Rough textured aggregates exhibit higher strength in tension as compared to smooth aggregates, but compressive strength is less because higher w/c ratio is required for the same workability. The texture of aggregate is shown in the **Table-1** given below :

**Table-1**

Particle Percentage		w/c ratio	28 day flexural strength (MPa)	28 day compressive strength (MPa)
Smooth	Rough			
100	0	0.54	4.3	34.8
50	50	0.57	4.6	32.1
0	100	0.64	4.8	29.5

**4. Water Absorption**

In mix-design calculations, we assume aggregate to be saturated and surface dry (SSD). Actually it may be in a different state of dryness as given under,

- (i) Bone dry
- (ii) Air dry
- (iii) Saturated and surface dry
- (iv) Moist

If aggregate is drier than SSD, it will absorb water from concrete and reduce the workability. On the other hand if it moist, it will contribute water in the concrete reducing the strength. The different stages can be as given in **Fig-1**.

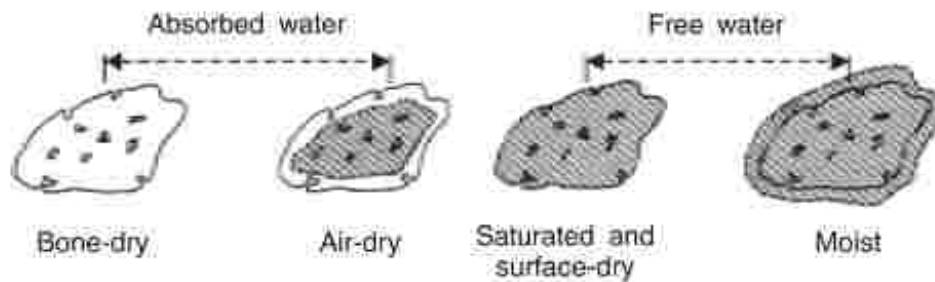

**Fig - 1 Water Absorption**

### **Phases of concrete**

In the total concrete volume, there are two important phases viz;

- (i) Paste phase
- (ii) Aggregate phase

In most of the cases of concrete failure, it is the paste phase which is a weaker link. The paste phase of concrete has the following characteristics :

- (i) It is weaker than aggregate
- (ii) It is vulnerable to most of the ill effects on concrete
- (iii) It is more permeable than any of the mineral aggregates
- (iv) It is susceptible to aggressive chemicals

Therefore, effort should be made to use minimum volume of paste in the concrete. It should just be sufficient to fill the voids left out by the aggregates and lubricate them properly. This can be achieved by using 'well graded aggregates' so that the voids are minimum.

### **Sieve Analysis of Aggregates**

It is a process of dividing a sample of aggregate into various fractions, each consisting of particles of same nominal size. The resultant 'particle size distribution' is called the gradation.

Standard sizes of the sieve are:-

80, 40, 20, 10, 4.75, 2.36, 1.18, 600 $\mu$ , 300 $\mu$ , 150 $\mu$

The gradation of aggregate is very important not only for concrete strength but for workability also. In fact the gradation of FA has much greater effect on concrete qualities. FA should not be very coarse as it may cause segregation or bleeding and also result into harsh concrete. It should not be very fine also, otherwise it will have more water demand.

The gradation of FA can be represented by a mathematical index called '**Fineness Modulus**' (FM) which determines relative fineness of material.

Mathematically,

FM = Cumulative percentage of aggregates retained on each standard sieves

Larger the value of FM, coarser will be the aggregate as given in **Table-2** below :

**Table-2**

<b>Sand</b>	<b>FM</b>
Fine Sand	2.2 – 2.6
Medium Sand	2.6 – 2.9
Coarse Sand	2.9 – 3.2

FM more than 3.2 is generally considered unsuitable for concrete.

As per IS:383-1970, the gradation of FA has been done by dividing into four zones i.e. Zone-I, Zone-II, Zone-III & Zone-IV. The grading limits are shown in **Table-3**.

**Table-3**

IS Sieve	Percentage Passing			
	Zone-I	Zone-II	Zone-III	Zone-IV
10 mm	100	100	100	100
4.75 mm	90-100	90-100	90-100	95-100
2.36 mm	60-95	75-100	85-100	95-100
1.18 mm	30-70	55-90	75-100	90-100
<b>* 600 <math>\mu</math></b>	<b>15-34</b>	<b>35-59</b>	<b>60-79</b>	<b>80-100</b>
300 $\mu$	5-20	8-30	12-40	15-50
150 $\mu$	0-10	0-10	0-10	0-15

\* Since the values for 600  $\mu$  size are not overlapping for different zones, it is used for confirming the zone of a sample of FA.

Zone-I represents the coarse and zone-IV represents the finer sand in all the four zones. Fine aggregate belonging to Zone-IV should not be used in RCC works unless tests have been made for suitability of mix proportion.

### **Quality of Aggregates**

The aggregate should be free from impurities like deleterious material, salt contaminations and alkali reaction. These are elaborated as under :

#### **(a) Deleterious Material**

Impurities and deleterious material like clay, silt, coal, lignite, mica, shale etc. interfere with the process of hydration and prevent bonding of aggregate with cement matrix.

#### **(b) Salt contamination**

This is the main problem mainly with sea dredged aggregate. These aggregates should not generally be used for PSC works. Even if these are permitted for PSC works, the limits should be as given in 'Concrete Bridge Code' (CBC) :



As per CBC:

Limit of chloride - 0.04% by weight of FA or  
0.02% by weight of CA

Limit for sulphate- 0.4% by weight of Total Aggregate

### (c) Alkali Reaction

Some aggregates contain active silica which may react with alkalis present in cement like sodium oxide, potassium oxide etc. Alkaline hydroxide derived from alkalis in the cement may attack these constituents and gels of 'unlimited swelling' is formed which results in cracking. This problem can be overcome if:

1. Low alkali cement is used (cement with alkali content < 0.6%)
2. Ground Pozzolana is added to the cement so that Pozzolana react with alkalis before they attack aggregates.

### Gap grading of Aggregates

This is relatively a different concept of aggregate gradation. It is different from the conventional adopted 'well gradation' or 'continuous gradation' which means representation of all the standard particle sizes in certain proportion. Assumption made in well gradation is that voids created by the higher size of aggregate will be filled-up by immediate next lower size of aggregate and again some smaller voids will be left out which will again be filled-up by next lower size aggregates.

But it is easier said than done. Practically it has been found that voids created by a particular size may be too small to accommodate the very next lower size. Therefore the next lower size may not be accommodated in the available gap without lifting the upper layer of the existing size. Therefore, 'Particle Size Interference' is created which disturbs the very process of achieving the maximum density.

In fact the size of voids created by a particular size of aggregates can accommodate the second or third lower

size aggregates only i.e. voids created by 40 mm will be able to accommodate size equal to 10 mm or 4.75 mm but not 20 mm. This concept is called 'Gap Grading'.

### Advantages of Gap Grading

1. Requirement of sand is reduced by 26 to 40%
2. Specific area of total aggregate will be reduced due to less use of sand
3. Point contact between various size fractions is maintained, thus reducing the drying shrinkage.
4. It requires less cement as the net volume of voids is reduced to a greater extent.

A word of caution while using gap grading is that sometimes it may lead to segregation and may even alter the anticipated workability. Therefore tests must be conducted before adopting this gradation.

### Bulking of Sand

It is the property of sand by virtue of which its apparent volume increases when some water is added to it. It happens mainly due to surface tension. This increase in volume will not take place when the sand is either dry or fully saturated. The bulking depends both on moisture content as well as particle size. Fine sand bulks more and very fine sand may bulk even up to 38-40%. The bulking is maximum at a particular moisture content as shown in the **Fig-2**.

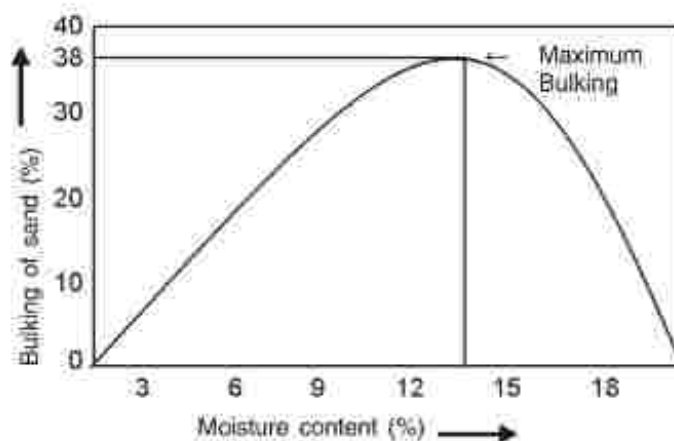

**Fig - 2 Bulking of sand**



## CHAPTER 4

# WATER & ADMIXTURE

## WATER

The quality of water needed for making good concrete is very important. The quality of water has great influence on strength as well as durability of concrete. There is a popular yardstick that water fit for drinking purpose can be used for concrete. But technically speaking various chemicals in water should be within the prescribed limits as given below:-

- (1) pH value of water should be between 6 and 8. The value less than 6 means acidic in nature which may lead to corrosion of reinforcement.
- (2) It should be free from organic materials and other impurities.

### Effect of Impurities of water

- (1) Carbonates and bicarbonates affect setting time of cement. Sodium carbonate causes quick setting.
- (2) If bicarbonate is more than 1000 ppm, tests for setting time and strength should be carried out.
- (3) Brackish water contain  $\text{Cl}^-$  and  $\text{SO}_4^{2-}$ . Chloride should not be more than 10,000 ppm and sulphate not more than 3000 ppm.
- (4) Turbidity should be limited to 2000 ppm. This is due to silt and other suspended material which interfere not only with setting, but also with hardening and bond characteristics.
- (5) Algae, if present in water, entraps a large amount of water which causes reduction in strength.

Generally the source of water should be reliable. In case of doubtful source, e.g. coastal area, marshy land and

other places where brackish water is available, we should compare the cube strength at 7 days and 28 days made with available water and distilled water. This will give an overall effect of the source water. If strength achieved with available water is up to 90% of the strength achieved with distilled water, and no other problem is reported, then the source of water may be accepted. But the tests should be conducted at regular intervals.

### **Effect of Sea Water**

Salinity of sea water is approximately 3.5%. If sea water is used, the main concern will be the corrosion of steel and reduction in strength. The strength reduction is about 10-15%. In addition, it also accelerates the setting time of cement, causes efflorescence and persistent dampness. Therefore use of sea water should be avoided for concrete works.

## **ADMIXTURE**

It is an optional ingredient of concrete which is added to modify the properties of fresh as well as hardened concrete and grout material as per some specific requirements. Addition of admixture may alter workability, pumping qualities, strength development, appearance etc. in fresh concrete and permeability, strength, durability etc. in hardened concrete. But use of chemical admixture is a must for producing high grade concrete.

### **Categories of Admixtures**

Various categories of admixtures are available in the market as given below:

- (1) Water reducing admixtures
- (2) Retarding admixtures
- (3) Air entraining admixtures
- (4) Accelerating admixtures

## 1) Water reducing admixtures

These admixtures reduce the requirement of water for a given workability. For full hydration a w/c of 0.23 is sufficient but generally much higher w/c ratio is adopted due to the requirement of workability. Workability is an equally important design parameter in addition to strength because inadequate workability leads to honeycombing and non uniform strength. Excess water is used to overcome the internal friction between solid particles of concrete and facilitate mixing, placing, transportation and compaction of concrete. There are two categories of water reducing admixtures.

- (a) Plasticizers
- (b) Super-plasticizers

Super-plasticizers are improvised version of conventional plasticizers. They reduce water requirement significantly. These are, therefore, also called 'High range water reducers'. Plasticizers reduce water requirement up to 15% whereas super plasticizers can reduce this requirement even up to 30%.

### Mechanism of water reduction

Water reducers are surface active chemicals called surfactants. In absence of water reducer, cement particles, being very fine, cling together and flocculate when water is added to cement. Due to flocculation, a lot of water is entrapped by cement particles and it becomes unavailable for workability. Water reducer admixtures induce negative charge on cement particles due to which the flocculated cement particles get dispersed due to repulsion. The entrapped water now becomes free and available for workability. The above action is a purely physical action as shown in **Fig-1**.

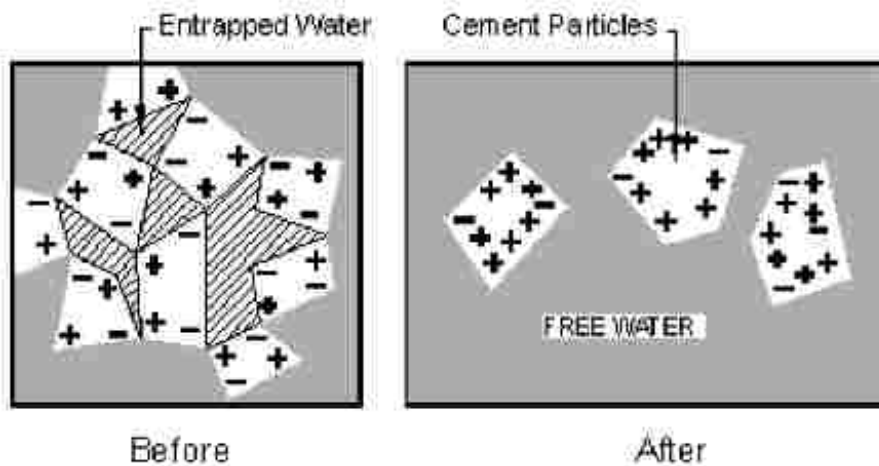

**Fig - 1 Physical Interaction of Super-Plasticizer**

But it may be associated with chemical interaction also which is mainly for slump retention. The admixtures get absorbed on hydrated phase containing silicates and aluminates and thus delay the gel formation. Thus the slump is retained.

Note: The admixtures should not be used as a substitute for bad construction practices or badly designed concrete. These should rather be considered as an aid to good construction practices.

## **2) Retarding Admixtures**

These admixtures are used where setting time of concrete needs to be delayed. Retarders delay the hydration process but doesn't affect the eventual process. Initial setting time can be delayed by more than 3 hours. The main application of retarding admixtures is in eliminating the cold joints and controlling the setting of concrete.

## **3) Air entraining Admixtures**

These are also surface active agents that form stable air bubbles of very small size ranging from  $5\mu$  to  $80\mu$ . The main function of air bubbles is to break capillary structure within the concrete and to act as roller ball bearings so that the particles in the mix move freely against each other, thus

improving the workability of concrete without adding more water.

#### **4) Accelerating admixtures**

These are used to accelerate the setting time and hardening process of cement in concrete. These are used in concreting under flowing water and in road repair works so that work can be put to use earliest as possible.

Among all above admixtures, water reducing agents or super-plasticizers are the most commonly used admixture for high performance concrete. There are four types of super-plasticizers which are generally used for concrete as explained below :

- (a) Sulphonated melamine  
It is suitable in low temperature areas
- (b) Sulphonated naphthalene  
It is more suitable in high temperature areas
- (c) Ligno sulphates  
It is suitable for Indian conditions where temperature variation is high.
- (d) Carboxylated  
It is suitable where workability is required to be retained for large duration.

#### **Factors affecting the performance of Admixture**

The various factors affecting the performance of admixture are as given below :

##### **1. Type of super-plasticizer**

The admixture will be more effective if molecular weight of the super-plasticizer is high.

##### **2. Dosages**

The quantity of admixture should be optimum. Excess of admixture may cause segregation or bleeding. It may also cause excessive retardation. The optimum dose should be estimated by trials.



### 3. Compatibility with cement

All admixtures may not produce same results with different cements. Therefore before using any admixture, its compatibility with cement has to be established. Properties of cement like fineness, chemical-composition,  $C_3A$  content etc. affect the performance of admixture. Therefore, trials have to be made before finalising an optimum dose of admixture.

### 4. Mix Design

All the constituents of mix affect the performance of the super-plasticizer as given below:

- (a) Water: More water in the mix improves the physical interaction and dispersion of admixtures.
- (b) Coarse Aggregate: Proportion and grading of CA influence the performance of admixture.
- (c) Fine Aggregate: Proportion, grading and silt content also influence the performance.
- (d) Cement: Its fineness,  $C_3A$  content influence the performance. Higher  $C_3A$  reduces efficiency of admixture.
- (e) Other Admixtures: Presence of other admixtures also influence the performance of super-plasticizers.

Therefore proper trials before actual use are very vital for effectiveness of admixture.

### 5. Other factors

Certain other factors like temperature and humidity at the time of concreting also affect the performance of the super-plasticizers. High temperature and less humidity lower the efficiency of admixture. Drum mixers are not considered ideal for mixing admixtures, instead we should use pan or compulsive shaft mixers.

### **Recommended Methods for better performance**

- (a) All aggregates, cement and approximately 2 litre less water should be fed into the mixer and mixed properly for 2 minutes.

- (b) Admixture is mixed in balance 2 litre of water and added in the mixer. Continue mixing for one more minute.
- (c) When transit mixer is used for transportation of RMC, add plasticizer only few minutes before loading into the transit mixer.
- (d) Add plasticizer in smaller dosages at regular interval. It will improves its effectiveness.
- (e) Initial overdose of plasticizer is required for initial high workability and additional dosage just before placement.

The effect of super-plasticizer can be understood in a better way by analysing the results of **Table-1** and curves in **Fig-2**.

**Table-1**

**A – Effect on Workability (keeping w/c same)**

Mix	Cement kg/m <sup>3</sup>	w/c	Slump (mm)	Strength (N/mm <sup>2</sup> )	
				7 days	28 days
Mix with cement only	440	0.37	25	39	54
Cement + 0.4% Admixture	440	0.37	100	41.1	54.1

**B – Effect on Strength (keeping workability same)**

Mix	Cement kg/m <sup>3</sup>	w/c	Slump (mm)	Strength (N/mm <sup>2</sup> )	
				7 days	28 days
Mix with cement only	315	0.60	95	21.8	29.1
Cement + 0.4% Admixture	315	0.53	95	28.5	37.5

Note: The percentage of admixture is by weight of cement.

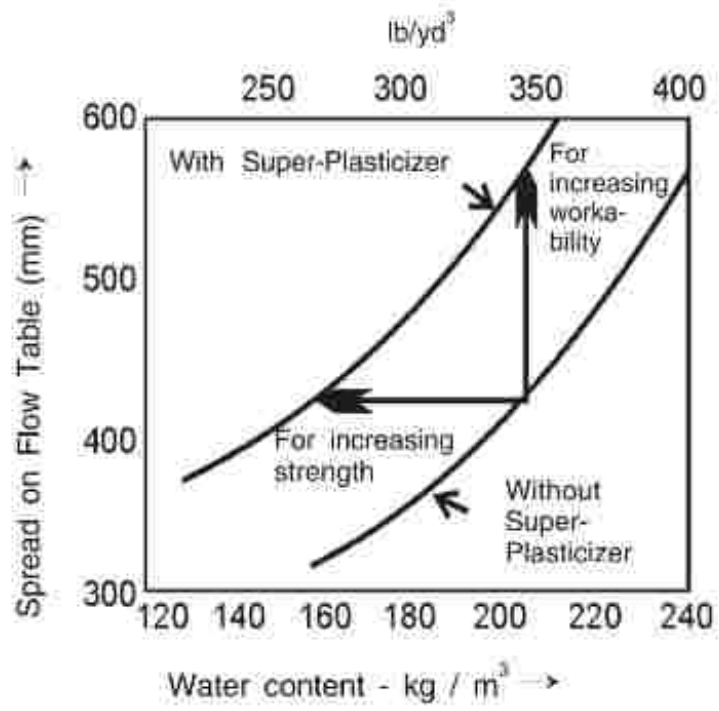

**Fig - 2 Effect of Super-Plasticizer**



## CHAPTER 5

# PRODUCTION OF CONCRETE

Production of concrete involves two distinct activities. One is related to 'material' and the other to 'processes'. The material part is generally taken care by every body, but the involved processes in the production of concrete are often neglected. Therefore no wonder that it is the 'process' which is responsible for good or bad quality of concrete. If we take care of processes, the quality of concrete will be improved automatically without incurring any extra expenditure as the major expenditure has already been made in procurement of material. In order to ensure the quality, it is very important to have a knowledge of each and every process.

### Process for Concrete Production

The various process involved in concrete production are as given below :

- 1) Proportioning
- 2) Mixing
- 3) Transportation
- 4) Placement
- 5) Compaction
- 6) Curing

#### 1) Proportioning

It is the relative quantity of each ingredient to make the desired concrete. It is decided based upon the calculations of mix-design. The proportioning should be such that the resultant mass should be compact with minimum voids and the required strength should be achieved.

## 2) Mixing

The purpose of proper mixing is to ensure that mass should become homogeneous, uniform in colour and uniform in consistency.

There are two types of mixing that are adopted in the field i.e. Hand Mixing and Machine Mixing

### (a) Hand Mixing

It is done manually and thus inferior to machine mixing as it can't give homogeneous and uniform concrete.

### (b) Machine Mixing

It is an efficient and economical way of mixing in which homogeneous and uniform mixing can be ensured. It can further be divided into two categories as given below :

- (i) Batch Mixing – The mixing of concrete is done in batches.
- (ii) Continuous Mixing – The mixing is done continuously till the plant is working. All the ingredients are fed through screw feeder in a continuous manner. It is used in large works such as dams and bridges.

## Type of Batch Mixers

- (1) Pan type mixers
- (2) Drum type mixers

### 1. Pan Type Mixers:

It consists of a circular pan rotating about a vertical axis with one or two stars scraper blades rotating about a vertical axis which is not matching with the axis of the pan. Scraper blades prevent sticking of mortar to the sides of pan. The pan mixers are particularly efficient for stiff and cohesive mixes.

These are mainly used in central batching plant on large projects or at pre-cast manufacturing units. A smaller version is generally available in laboratories too.

## 2. Drum Type Mixers:

There are three types of drum mixers as given below :

- (a) Tilting – The rotating drum is able to tilt. This type of mixer is normally used in the field.
- (b) Non-Tilting - The rotating drum is not able to tilt, therefore separate entry and exit for concrete is provided.
- (c) Reversing or Forced Action - It is similar to non-tilting but entry and exit of concrete is provided on the same side.

This mixers are shown in **Fig-1**.



**Fig-1 Drum Mixers**

As per IS:1791-1963, the mixers are designated by capacity as given below :

Tilting : 100T, 140T, 200T

Non-Tilting : 200NT, 280NT, 375NT, 500NT and 1000NT

Reversing : 200R, 280R, 375R, 500R and 1000R

Here Figure represents capacity in litre and words represent like: T for Tilting, NT for Non-tilting & R for Reversing.

### **Sequence of charging ingredients**

Based upon the field experience, it has been found that the following sequence of charging should be adopted in the field for achieving homogeneous and uniform mixing.

- (i) Half the quantity of CA
- (ii) Half the quantity of FA
- (iii) Full quantity of cement
- (iv) Remaining quantity of CA
- (v) Remaining quantity of FA
- (vi) 25% of total water is introduced before loaded skip is discharged into the drum. This will prevent sticking of cement on blades or bottom of drum. The balance 75% of water is added after loaded skip is discharged into the drum.

### **Mixing time**

It is the time required to mix the ingredients so as to obtain a homogeneous and uniform consistency mass of concrete. The time is reckoned from the moment all the ingredients including water has been added. Generally 25 to 30 revolutions of drum mixer are sufficient for proper mixing. The drum mixer rotate @ 15-20 rpm, therefore it will take approximately 2 minutes for proper mixing.

Mixing time also depends upon the grade of concrete. Richer mix requires more time. Similarly mixing time will depend upon type of aggregate also and more time will be taken for crushed aggregates as compared to smooth aggregates. In case of doubt it is always better to mix for a longer time. More mixing may sometimes result into higher strength also probably due to:

- (i) Reduced w/c due to evaporation and absorption by aggregates
- (ii) Increased workability due to abrasion action and rounding of coarse aggregates.

### **3) Transportation**

Transportation of concrete is an important activity in the production of concrete. The time taken in transit should be a design parameter as it depends on the initial setting time as well as the requirement of workability at the



destination. The method of transportation adopted at site should be decided in advance so that suitable admixtures can be decided. The various prevalent methods of transportation are as given below :

(a) Mortar pan

It is a labour intensive method and generally used for small works. There are no chances of segregation of concrete. In hot weather, there is a substantial loss of water due to more exposure of concrete to environment.

(b) Wheel barrow or hand cart

It is normally used on ground level i.e. road construction and other similar structures. Segregation can occur if transportation is done on rough roads however this problem can be minimized if pneumatic tyres are used.

(c) Bucket and ropeway

It is suitable for works in valley, over high piers and long dam sites. Excessive free fall of concrete should be avoided to avoid segregation.

(d) Truck mixer and dumper

It is an improved and better method for long lead concreting. The concrete is covered with tarpaulin if it is transported in open trucks. If long distance is involved, agitators should be used.

(e) Belt conveyer

It has limited application due to chances of segregation on steep slopes, roller points and change in direction of belt. It also involves over-exposure of concrete to environment.

(f) Chute

It is generally used for concreting in deep locations. Care should be taken that slope should not be flatter than 1V : 2.5H, otherwise concrete will not slide-down. But workability should not be changed to suit the delivery by chute. Technically it is not a very good method but it is extensively used in the field.

(g) Skip and hoist

It is a widely used method for high rise structures. Concrete is fed into the skip which travels vertically on rails like a lift. After discharging, it is better to turn over the concrete before use to avoid segregation.

(h) Pump and Pipe-line method

It is the most sophisticated method particularly suitable for limited space or when a large quantity of concrete is to be poured without cold joints. Pumping of concrete can be done @ 8 to 70 cum per hour up to a horizontal distance of 300 m and vertical distance of 90 m. Pipe dia is generally 8-20 cm and it is made of steel, plastic or aluminium. The workability for pumped concrete should have a minimum of 40-100 mm of slump or 0.90-0.95 CF. At delivery point, the workability may be reduced by 25% due to compaction and this factor should be kept in mind while designing the mix.

At the end of day's work, the pipe should be cleaned by passing a special ball called 'go devil' forcing through the pipe by air pressure.

The various parts of the system are as shown in Fig-2.

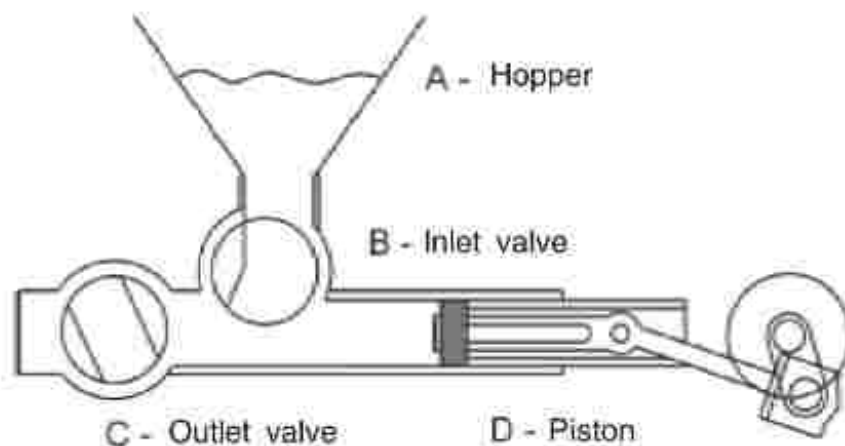

**Fig - 2 Concrete Pump**

#### **4) Compaction**

Compaction is a process of expelling the entrapped air. If we don't expel this air, it will result into honeycombing and reduced strength. It has been found from the experimental studies that 1% air in the concrete approximately reduces the strength by 6%.

There are two methods of compaction adopted in the field as given below:

- (a) Hand compaction
- (b) Mechanical compaction

##### **(a) Hand Compaction**

Hand compaction is used for ordinary and unimportant structures. Workability should be decided in such a way that the chances of honeycombing should be minimum. The various methods of hand compaction are as given below:

(i) Rodding – It is a method of poking with 2 m long, 16 mm dia rod at sharp corners and edges. The thickness of layers for rodding should be 15-20 cm.

(ii) Ramming – It is generally used for compaction on ground in plain concrete. It is not used either in RCC or on upper floors.

(iii) Tamping – It is a method in which the top surface is beaten by wooden cross beam of cross section 10 cm x 10 cm. Both compaction and levelling are achieved simultaneously. It is mainly used for roof slabs and road pavements.

##### **(b) Mechanical Compaction**

Vibration is imparted to the concrete by mechanical means. It causes temporary liquefaction so that air bubbles come on to the top and expelled ultimately. Mechanical vibration can be of various types as given under :

(i) Internal vibration

It is most commonly used technique of concrete vibration. Vibration is achieved due to eccentric weights attached to the shaft. The needle diameter varies from 20 mm to 75 mm and its length varies from 25 cm to 90 cm. The frequency range adopted is normally 3500 to 5000 rpm. The correct and incorrect methods of vibration using internal vibration needles are shown in **Fig-3(a)**, **3(b)**, and **3(c)**.

(ii) External vibration

This is adopted where internal vibration can't be used due to either thin sections or heavy reinforcement.

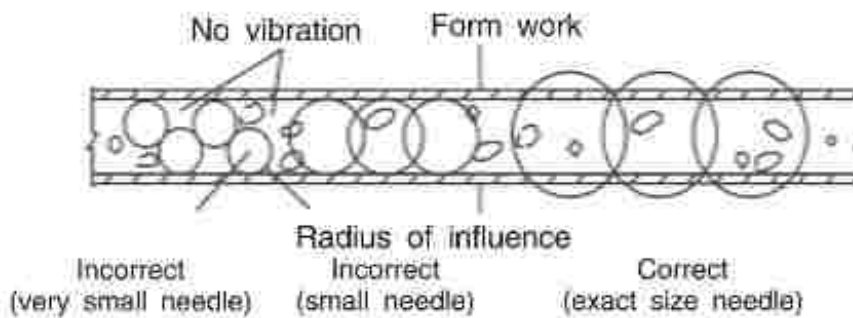

**Fig-3 (a)**

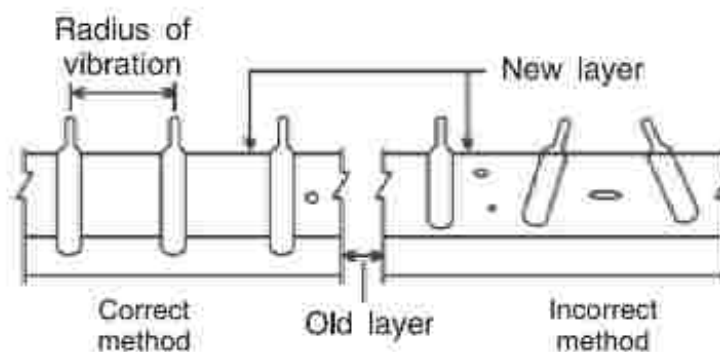

**Fig-3 (b)**

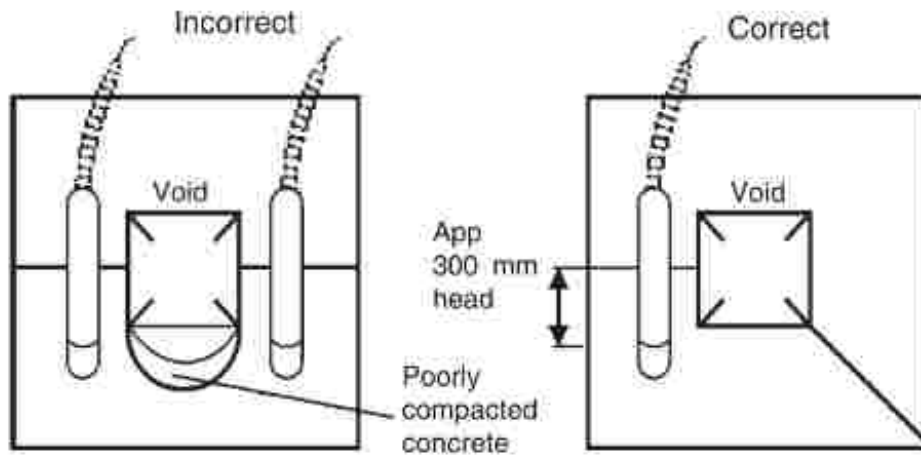

**Fig-3 (c)**

External vibration is less effective and it consumes more power as compared to the internal vibration. The formwork also has to be made extra strong when external vibration is used.

(iii) Table vibration

It is mainly used for laboratories where concrete is put on the table.

(iv) Platform vibration

It is similar to table vibrators but these are generally used on a very large scale.

(v) Surface vibration

These are also called screed board vibrators. The action is similar to that of tamping. The vibrator is placed on screed board and vibration is given on the surface. It is mainly used for roof slabs, road pavements etc. but it is not effective beyond 15 cm depth.

**5) Curing**

Curing is a procedure of promoting the hydration of cement for development of concrete strength and controlling the temperature. As a result of curing, we can achieve higher strength and reduced permeability which is very vital

for the long term strength or durability. The effect of curing has been depicted in Fig-4.

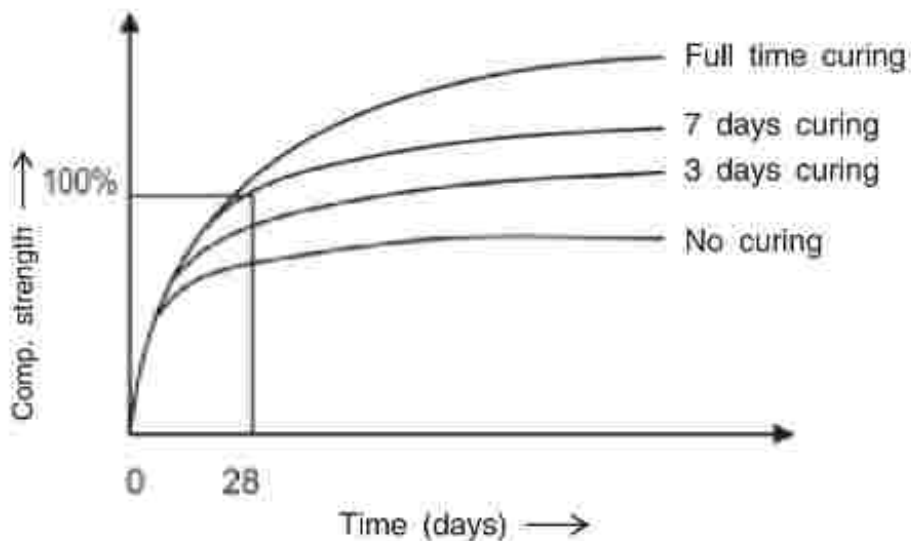

**Fig-4 Effect of curing**

The curing is required for full development of strength. Initially the entire concrete has sufficient quantity of water for hydration. But over the passage of time, the water is lost due to evaporation or it is consumed due to reaction of hydration. The relative humidity, thus, falls below 80% level and the hydration process eventually stops.

### **Methods of curing**

Various methods of curing are adopted in the field as given below :

#### **(a) Replenishing the lost water**

- (i) By immersion in water
- (ii) By ponding
- (iii) By sprinkling
- (iv) Using saturated coverings, e.g. jute bags etc.

#### **(b) Preventing loss of moisture**

- (i) Using curing compounds
- (ii) Using impermeable membrane coverings

Out of above methods, immersion may be the ideal method of curing but it is not practicable always. It is restricted to laboratories or pre-cast units where small units like cubes or PSC sleepers etc. can be immersed in water. Ponding is suitable only for flat surfaces but not for vertical or overhead surfaces. Sprinkling is the most commonly used method in the field but it requires a large quantity of water. Saturated covering is a better method which requires less quantity of water. Curing compounds are effective for concrete with high initial w/c ratio. Impermeable membrane is also having the same effect as of curing compounds. Out of these methods, the most widely used method in the field is saturated coverings using jute bags.

### **Important observations regarding curing**

- (1) Curing should be started earliest as possible.
- (2) For the portion of concrete which is covered with formwork, the curing should be started as soon as the formwork is removed.
- (3) On exposed surface, it should be started when concrete has sufficiently hardened such that it doesn't get disturbed by curing.
- (4) Ensure uninterrupted curing. If it is discontinued for any reason, the reaction of hydration will be stopped permanently. The partial hydration makes the capillary pores discontinuous and water can't enter the concrete even if the curing is started again.
- (5) High strength concrete should be cured at an early age.
- (6) There is a widespread belief that humid climate is sufficient and curing is not required in rainy season.
- (7) The person generally entrusted for curing is the most unskilled person. He doesn't appreciate the importance of curing. In fact he believes that curing is a process of wastage of water time and money.
- (8) It can't be made a measurable item in the contract.



Therefore the best and practical method to ensure proper curing is the education of the person who is responsible for curing. Once he understands the importance of curing, he would certainly ensure it.

■ ■ ■

## CHAPTER 6

# MIX DESIGN

### Definition of mix design

It is a process of selecting suitable ingredients and determining their relative proportions with the objective of producing concrete of having certain minimum workability, strength and durability as economically as possible.

Design of a mix not only needs the knowledge of properties of all ingredients and the properties of concrete in plastic condition, but it also require wider knowledge and experience of concreting. Without experience, a person will be like a novice and inexperienced cook equipped with a recipe book. Good food and good concrete both can't be produced without experience.

### Types of Mix Design

A mix can be designed in two ways as explained below :

1. Nominal Mix
2. Design Mix

#### 1. Nominal Mix

It is used for relatively unimportant and simpler concrete works. In this type of mix, all the ingredients are prescribed and their proportions are specified. Therefore there is no scope for any deviation by the designer. Nominal mix concrete may be used for concrete of M-20 or lower. The various ingredients are taken as given below in **Table-1**.

Table-1

Grade	Max. Qty of Dry Aggregates per 50 kg of cement	FA : CA by mass	Max. quantity of water in litres
M-5	800	Generally 1:2 but may varies from 1:15 to 1:2.5	60
M-7.5	625		45
M-10	480		34
M-15	330		32
M-20	250		30

## 2. Design Mix

It is a performance based mix where choice of ingredients and proportioning are left to the designer to be decided. The user has to specify only the requirements of concrete in fresh as well as hardened state. The requirements in fresh concrete are workability and finishing characteristics, whereas in hardened concrete these are mainly the compressive strength and durability.

### Designation of concrete

Concrete is generally characterized by 'compressive strength' and designated by 'Grade of concrete'. As per IS 456:2000, the grade of concrete is 28 days characteristics compressive strength of concrete cube of 15 cm size expressed in  $N/mm^2$ .

### Sampling

1. The number of samples to be taken depend upon the quantity of concrete being done on a particular day as shown below in **Table-2**.

However, a minimum of one sample should be taken even if the concrete used is less than one  $m^3$  on a particular day or in a particular shift.

**Table-2**

<b>Quantity of concrete (m<sup>3</sup>)</b>	<b>No. of samples</b>
1 – 5	1
6 – 15	2
16 – 30	3
31 – 50	4
51 & above	4 + 1 for each 50 m <sup>3</sup> or part thereof

2. The sample should represent the actual concrete being used in the structure.

3. The samples should be taken at random and it should be representative sample.

### **Cube Casting**

Cubes are cast with the same concrete which is being used in the structure. Concrete is filled up in the mould in three equal layers, each layer being tamped with the help of a bullet headed tamping rod of 16 mm  $\phi$  and 600 mm length by giving 35 strokes in each layer. Alternatively, the compaction can also be done using needle vibrator but instead of inserting the needle into the mould, the vibration should be given indirectly by placing a wooden piece over the cube and touching the needle at middle of the wooden piece.

Light marking of date and number is made on the green concrete. The cube in the mould is covered with a damp cloth. It is stripped only after 16-24 hours and then submerged in clean water pond till the testing is done.

## Cube Testing

In fact, 3 cubes constitute one sample. In one sample, the strength of individual cube should not vary by more than  $\pm 15\%$  of average strength of three cubes of sample, otherwise the sample is considered to be invalid. At the time of testing, the cube should be so placed on the machine such that smooth faces should be on top and bottom. The rate of loading should not be more than  $14 \text{ N/mm}^2$  per minute, otherwise the results will not be accurate.

## Importance of Cube Test

Although cube strength does not represent the actual strength of concrete in the structure because of many reasons as explained in the forthcoming paragraphs, yet the importance of cube testing can't be underestimated because of the following reasons:

- (i) It indicates the potential strength of the mix.
- (ii) It detects the variation in quality control at site.
- (iii) It helps in determining the rate of gain of strength of concrete.
- (iv) It helps in determining the time of removal of form work.

However as explained above, the cube strength does not guarantee the same strength in the structure because of the following reasons:

- (i) The concrete in cubes does not pass through the misadventures of transportation, placement, compaction and curing. All these processes are much superior in cube as compared to the structure.
- (ii) Its shape is different from the shape of structures. Therefore the shape factor also plays an important part in strength. The strength of the actual structure is approximately  $2/3^{\text{rd}}$  of cube strength for the same concrete.

## Statistical interpretation of cube results

A number of factors can influence the results of the cube test like material, their proportions, various processes like mixing, compaction and curing and finally the testing procedure of cubes. Even the results of different cubes cast from the same concrete at the same time, cured and tested in similar way may also show different results. Therefore, for evaluation of the test results, the help of statistical approach is required.

When the test results of a large number of cubes, prepared under similar conditions, are plotted on a histogram, the results are found to follow a definite 'bell shaped curve' known as 'Normal Distribution Curve'. It will be further observed that a large number of cubes will have the strength near the mean value and the no. of cubes having more or less strength will reduce progressively depending upon the difference from the mean value. This deviation in strength represents quality control in the field. As shown in **Fig-1**, the quality control of curve 1 is very good, for curve 2 it is good and for curve 3 it is poor.

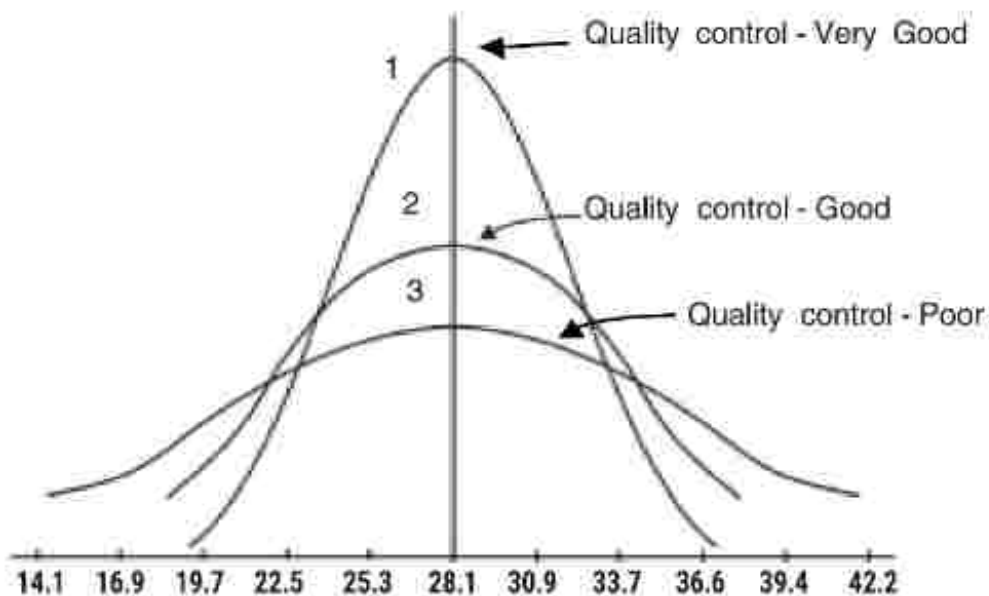

Fig-1

Statistically this deviation is known as '**Standard Deviation**' and it can be calculated by the formula given below.

$$\text{S.D. } (\sigma) = \sqrt{\frac{\sum (x - \mu)^2}{n - 1}}$$

Where:  $x$  = value for individual cube

$n$  = total number of cubes.

$\mu$  = Arithmetic mean of 'n' cubes

S.D. will be less if the 'Quality Control' at site is better and most of the cube results will be clustered near the mean value. If quality control is poor, the test results will have value much different from mean value and therefore, Standard Deviation will be higher.

### **Target Mean Strength**

From the behaviour of the 'Normal Distribution Curve', it is clear that when we are testing a large number of cubes, all the cubes will not have the same strength even if these are cast and tested in identical conditions. Some cubes will have higher strength than mean value whereas other cubes will have lower strength. The deviation from the mean value is indicated by 'Standard Deviation'. It has been found from the experiments that the area under the 'Normal Distribution Curve' will follow certain behaviour such that the area covered within a distance equal to one S.D. on either side from mean will be equal to 34.1% of total area. Similarly second and third S.D. on each side will cover additional area of 13.6% and 2.2% respectively. Combined together, approximately 99.9% area will be covered within distance equal to 3 x S.D. on each side from mean value as shown in **Fig-2**.

From this figure it is also clear that if we require the strength equal to mean value, probability is that only 50% cubes will have strength equal to or more than the required strength. If we want to increase the percentage of cubes



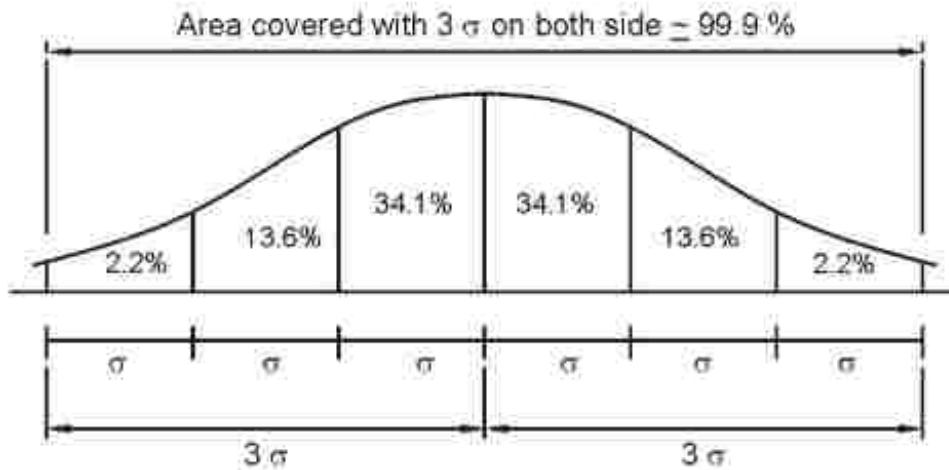

Fig-2

having strength equal or more than the required strength, we will have to target for higher strength. So instead of placing the desired strength at mean value, place it on the left side of mean value by a distance equal to  $k \times S.D.$  where  $k$  will depend upon the percentage of cubes we want to have strength equal or more than the desired strength. This is depicted in Fig-3.

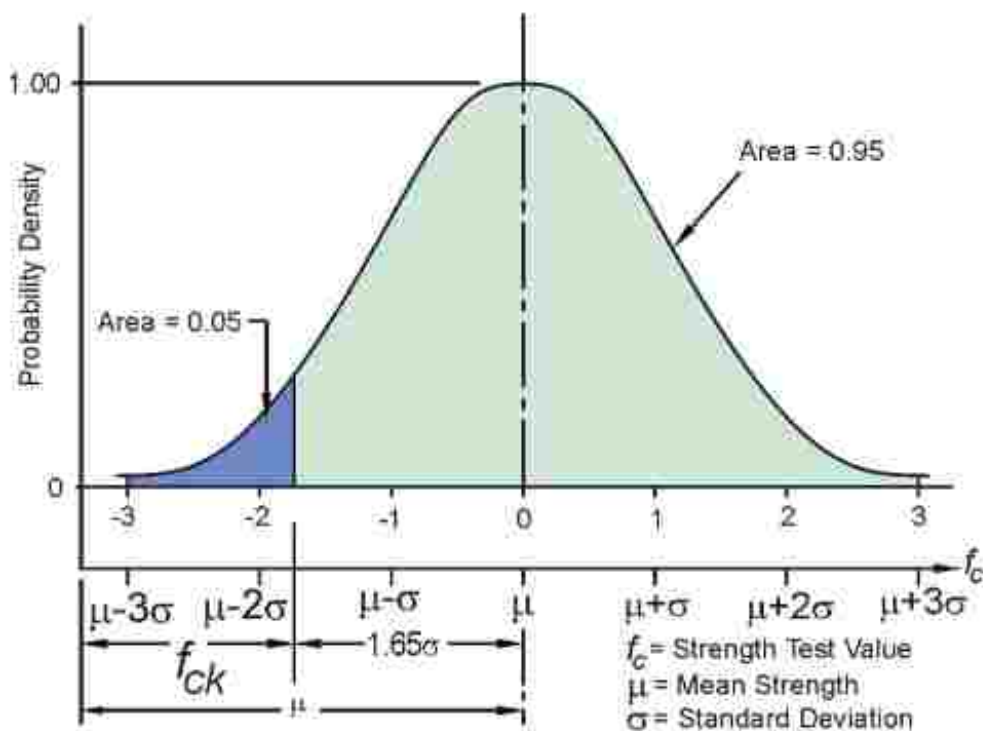

Fig-3

As per IS : 456:2000, this percentage is 95% and therefore the desired strength has to be placed 1.65 times S.D. left of mean, such that now

$$\text{mean} = \text{desired strength} + 1.65 \times \text{S.D.}$$

In fact, the desired strength is called 'Characteristic Strength' and the mean value is called 'Target Mean Strength'. Therefore,

$$\text{TMS} = f_{ck} + 1.65 \times \text{S.D.}$$

The value of 1.65 is based upon the provision that 5% of the test results can be accepted having lower than the required strength.

### Understanding of Normal Distribution Curve

The ordinate, 'Probability Density' as given in **Fig-3** is often misunderstood. It doesn't represent the number of cubes at a particular strength. In fact, it shows the probability of concentration of test results at this strength as shown in **Fig-4**.

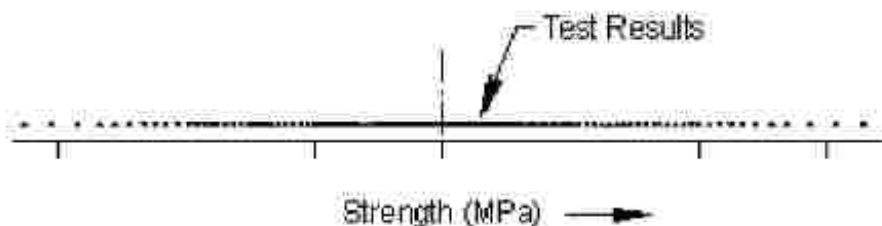

**Fig-4 Probability Density of cube results**

The concentration at mean value depends upon 'quality control' and S.D. If value of S.D. is less, the probability of concentration of test results will be higher at the mean value and therefore, the curve will shrink from both side and rise at centre as shown by 'curve 1' in **Fig-1**.

### Acceptance Criteria (As per IS-456:2000)

While designing the mix, we have to target for a higher strength called 'Target Mean Strength' so that not more than 5% test results fall below a desired strength called 'f<sub>ck</sub>' i.e. Characteristics Strength (CS).

When we test a large number of cubes, a few cubes will certainly have strength below CS. This is perfectly in accordance with the design criteria of mix. Therefore, we should not worry if some of the cubes have less strength than CS. We should also not attempt to manipulate the test results.

As per IS-456:2000, there is a well-defined criteria for acceptance of compressive strength of cubes. The test result will be accepted when the following two criteria are satisfied.

(a) The mean strength determined from any group of four consecutive test results should comply with the following condition:

(i) For M-15

$$\begin{aligned} \text{Mean} &\geq f_{ck} + 0.825 \times \text{S.D.} \quad \text{or} \\ &\geq f_{ck} + 3 \text{ N/mm}^2 \quad \text{whichever is greater.} \end{aligned}$$

(ii) For M-20 & above

$$\begin{aligned} \text{Mean} &\geq f_{ck} + 0.825 \times \text{S. D.} \quad \text{or} \\ &\geq f_{ck} + 4 \text{ N/mm}^2 \quad \text{whichever is greater.} \end{aligned}$$

(b) Any individual test result should not have value less than  $f_{ck} - 3 \text{ N/mm}^2$  for M-15 and  $f_{ck} - 4 \text{ N/mm}^2$  for M-20 and above.

Note : In above criteria, S.D. should be established at site after obtaining the test results of a minimum 30 samples.

**Example :**

Check the following test results according to Acceptance Criteria assuming  $f_{ck} = 20 \text{ N/mm}^2$  and established standard deviation of  $3.4 \text{ N/mm}^2$ .

22, 24, 23, 22.9, 22.75, 24.75, 24.50, 19.50, 24.9, 25.2, 23.75, 18 (All in  $\text{N/mm}^2$ )

**Solution :**

In above results, we should not worry even if some of the test results are having value less than  $f_{ck}$ . We have to check the test results as per Acceptance Criteria as given below :

- (i) The mean of 4 consecutive test results should be  
 $\geq f_{ck} + 0.825 \times 3.4$  or  $\geq 22.81 \text{ N/mm}^2$
- (ii) Individual result should not be less than  
 $f_{ck} - 4$ , i.e  $20 - 4 = 16 \text{ N/mm}^2$

Calculating mean of set of four cubes

$$\text{Mean of 1st set} = \frac{22 + 24 + 23 + 22.9}{4} = 22.98$$

$$\text{Mean of 2nd set} = \frac{22.75 + 24.75 + 24.50 + 19.50}{4} = 22.88$$

$$\text{Mean of 3rd set} = \frac{24.9 + 25.2 + 23.75 + 18}{4} = 22.96$$

The mean of all the three sets are more than or equal to 22.81, therefore, first criteria is satisfied and since no test result is having value less than  $16 \text{ N/mm}^2$ , the second criteria is also satisfied.

Therefore, even if the two results are having value less than  $20 \text{ N/mm}^2$ , the above results have passed the criteria for acceptance.

**Acceptance criteria (As per CBC)**

In CBC, the values are for M-20 and above only. The two criterion are as given below :

- (a) The mean of 4 consecutive test results should exceed ' $f_{ck}$ ' by at least  $3 \text{ N/mm}^2$ .
- (b) Any individual test result should not be less than ' $f_{ck}$ ' by  $3 \text{ N/mm}^2$ .

## Mix Design Example

(As per IS : 12062-2009)

### Input Data :

(a) Concrete Requirements :

Grade of concrete = M-20 (for R.C.C.)

Workability = 25 to 50mm slump

Exposure condition = Moderate

(b) Material

Grade of cement = 43 satisfying IS:269:1989

Max. Size of Aggregate (MSA) = 20 mm

Sand = Zone-I (As per IS : 383-1970)

Type of Aggregate : Angular

Specific Gravity :

Cement = 3.15

Course Aggregate = 2.5

Sand = 2.7

### Solution :

#### Aim of Mix Design :

Before attempting to design a mix with the above requirements i.e. strength and workability, we should be clear about what we are going to do. It is not simply a series of calculations for obtaining the quantities of various materials i.e. cement, sand, coarse aggregates and water. In fact it is much more than that. Mix design means obtaining our own curve representing the relationship between strength and water-cement ratio.

We know the trend of the curve. The strength will reduce with increase in water-cement ratio. But we want the exact relationship corresponding to the actual material used at site and actual workmanship achieved at site. Thus the entire exercise of designing a mix is the process of obtaining our own curve between strength and water-cement ratio and then specifying the proportions of all the ingredients.

### Step-1 Target Mean Strength

$$\text{TMS} = \text{fck} + 1.65 \times \text{Standard Deviation (S.D.)}$$

where

fck = Characteristic strength of concrete

SD depends upon grade of concrete and 'Quality Control' of concrete. The assumed S.D. as per IS : 10262-1982 are given in **Table-3**.

**Table-3**

Grade of Concrete	Assumed S.D. Value in N/mm <sup>2</sup>
M-10 & 15	3.5
M-20 & 25	4.0
M-30 to 55	5.0

In our problem, the concrete grade is M-20. Therefore the value of S.D. is 4.0.

$$\begin{aligned} \text{Therefore, TMS} &= 20 + 1.65 \times 4.0 \\ &= 26.60 \text{ N/mm}^2 \text{ or } 27 \text{ N/mm}^2 \end{aligned}$$

### Step- 2 Water-Cement Ratio

A graph between 28 days compressive strength in N/mm<sup>2</sup> and w/c ratio is available for different grades of cement. In graph there are 6 curves, A to F, depending

upon 28 days strength of cement. Curve A is at bottom showing less strength of cement and Curve F is at the top representing highest strength of cement. Therefore, before using this graph, we have to find the actual 28 days strength of cement and then identify the curve to be used depending upon this strength.

Let us assume curve 'C' belongs to cement used in our Mix. For curve 'C', the value of w/c ratio obtained from the graph is 0.47 corresponding to TMS = 27 N/mm<sup>2</sup>.

This w/c ratio shall be compared with the maximum w/c ratio permissible from the durability consideration. For bridge construction, we can refer Para 5.4.3 of 'Concrete Bridge Code'. From this consideration, the value of maximum w/c ratio for RCC construction and 'Moderate' exposure condition is 0.45. Therefore, we adopt the lower of two i.e. 0.45.

### Step- 3 Estimation of air in concrete

The entrapped air in concrete depends on nominal size of aggregate. More air is entrapped in smaller size aggregates as compared to larger size as given below in **Table-4**

**Table-4**

Nominal Maximum Size of Aggregates	Entrapped Air (% volume of concrete)
10 mm	3%
20 mm	2%
40 mm	1%

In our problem, for 20 mm size of aggregate, the entrapped air will be 2%.



#### Step- 4 Estimation of water and sand in concrete

The quantity of water and sand in concrete depends upon MSA and Grade of concrete. Less water is required for higher grade of concrete and higher size of aggregates. The values as per IS : 10262 – 2009 are given in **Table-5**.

**Table-5**

MSA (mm)	Quantity of water for each m <sup>3</sup> of concrete	Percentage of coarse aggregate by volume of total aggregates			
		Zone	IV	III	II
10	208	50	48	46	44
20	186	66	64	62	60
40	165	75	73	71	69

For our problem, MSA = 20 mm and Grade of Concrete = M-20

Therefore, quantity of water = 186 kg per m<sup>3</sup> of concrete.

$$p = \frac{\text{Volume of sand}}{\text{Total volume of aggregate}} = 1 - 0.6 = 0.4 \text{ (for zone I)}$$

But the values given in the above table are based on the following assumptions :

- (1) Workability of concrete is 25 to 50mm slump.
- (2) w/c ratio is 0.50.
- (3) Angular aggregates are used.

When the above conditions regarding workability, w/c ratio, fine aggregates etc. are not fulfilled, then certain adjustments need to be made in water content and percentage of sand. These adjustments will be as given in **Table-6**.

**Table-6**

Change in condition	Adjustment in	
	Water content	% age of sand in total aggregates
Increase/decrease of workability by each 25mm from 25 to 50mm slump	± 3%	NIL
Each 0.05 increase or decrease in water cement ratio w.r.t. 0.50.	NIL	± 1%
For rounded aggregates	-25 kg/cm <sup>3</sup>	- 7%

In our problem, the following adjustment will be made as given in **Table-7**.

**Table-7**

Conditions in our problem	Adjustment in	
	Water content	% age of sand in total aggregates
Workability 25 to 50 mm slump.	NIL	NIL
Decrease in water content 0.5 – 0.45 = 0.05	NIL	-0.05/0.05 = -1 %
Angular aggregates	NIL	NIL
Total	NIL	- 1%

Final value of water content = 186 kg  
 Final Value of p = 40 – 1 = 39%

### Step-5 Calculation of cement quantity

$$C = w/(w/c) = 186/0.45 = 413 \text{ kg}$$

This quantity of cement needs to be checked against requirement from durability consideration.

From Concrete Bridge Code for RCC structure (Moderate exposure) :

Min. cement = 300 kg

Max. cement = 500 kg

Hence the calculated value of C = 413 kg  
is adopted.

### Step-6 Calculation of Aggregate content

We have already calculated water and cement for one cubic meter of concrete. Since the ratio of fine to total aggregate is already determined, the total aggregate content per unit volume of concrete can be calculated from the equation given below :

Gross vol. of conc. = Volume of water + volume of cement  
+ volume of total aggregates  
+ volume of entrapped air in concrete

Net volume (V) = Volume of water + volume of cement  
+ volume of total aggregates

$$p = \frac{\text{Volume of fine aggregate}}{\text{Volume of total aggregate}}$$

or

Volume of total aggregate =  $1/p \times$  volume of fine aggregate

Therefore,

$$V = (\text{Wt of water/sp. gr. of water}) + (\text{Wt of cement/sp. gr. of cement}) + 1/p \times \text{volume of fine aggregate}$$

or

$$V = \frac{W}{1} + \frac{C}{S_c} + \frac{1}{p} (\text{wt. of fine aggregate/sp.gr.of fine aggregate})$$

$$V = \frac{W}{1} + \frac{C}{S_c} + \frac{1}{p} \frac{FA}{S_{fa}} \dots\dots\dots (1)$$

In this equation, we know all the variables except FA, i.e. total weight of fine aggregate per m<sup>3</sup> of concrete.

$$0.98 \times 1000 = \frac{186}{1.0} + \frac{413}{3.15} + \frac{FA}{0.39 \times 2.7}$$

∴ Wt. of fine aggregate FA = 698 kg

Similarly using the equation for CA

$$V = W + \frac{C}{S_c} + \left( \frac{1}{1-p} \right) \frac{CA}{S_{ca}} \dots\dots\dots (2)$$

$$0.98 \times 1000 = \frac{186}{1.0} + \frac{413}{3.15} + \left( \frac{1}{1-0.39} \right) \times \frac{CA}{2.5}$$

Wt. of coarse aggregate CA = 1011 kg

Therefore, the values obtained per cubic metre of concrete so far are as given under:

Cement	= 413 kg
Water content	= 186 kg
Fine aggregate	= 698 kg
Coarse aggregate	= 1011 kg

### Step-7 Trial Mixes

Prepare the concrete mix with the above proportion of ingredients and find out the workability. Let us call this trial mix as **TM-0**. If the workability is exactly same as required i.e. 25 to 50mm slump, then no further adjustment is made. But if the measured workability is different from

initially assumed, then water content adjustment will again be made accordingly to **Table-6**. Keeping the water cement ratio same, the quantity of cement will also be adjusted. Now the final quantities of other materials will again be calculated using the equations (1) and (2) as the water and cement quantities have changed now. Let us call this trial mix as **TM-1**.

Two more trial mixes **TM-2** & **TM-3** will be made, one with 10% less w/c and other with 10% more w/c but keeping the water content same. All these trial mixes are shown in **Table-8**.

**Table-8**

	<b>Water (kg)</b>	<b>Cement (kg)</b>	<b>w/c</b>	<b>FA (kg)</b>	<b>CA (kg)</b>
<b>TM-0</b>	W=186	C=413	0.45	698	1011
<b>TM-1</b>	W1	C1	0.45	FA1	CA1
<b>TM-2</b>	W1	C2	0.9x0.45	FA2	CA2
<b>TM-3</b>	W1	C3	1.1x0.45	FA3	CA3

Now we will cast one sample (three cubes) with each trial mix and find out the 28 days' compressive strength. This strength is plotted against w/c ratio and a curve will be obtained as given under in **Fig-4**.

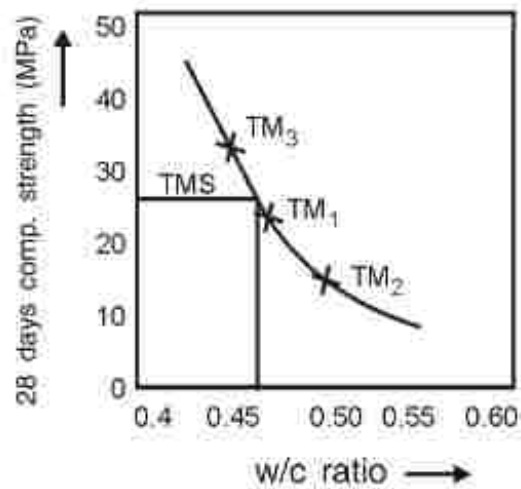

**Fig-4 Strength v/s w/c ratio**

From the above curve we can determine the w/c for the required TMS of our design mix. This w/c is used to calculate again the ingredient quantities using equation (1) and (2), so that the mix prepared with these quantities will satisfy the requirements of not only strength but workability also. This entire process is nothing but the mix-design.

■ ■ ■

## CHAPTER 7

### DURABILITY OF CONCRETE

Today durability of concrete has become the greatest concern of civil engineers. In the recent past, a few bridges have collapsed, highlighting the need for durability. Mandovi road bridge of Goa collapsed in 1986 and Poonam Chambers Bridge of Mumbai collapsed in 1997. Similarly many other bridges like Thane Creek road bridge Mumbai, Vasai creek road bridge Mumbai and Zuari bridge Goa have become distressed. All these bridges are on coastal regions, therefore, the needle of suspicion points to the corrosion of reinforcement. In most of the cases the primary reason for distress is not the quality of construction, but the lack of awareness of 'durability' concept.

Till recent years, our main concern was the strength of concrete indicated by cube strength. Now we have realised that in addition to cube strength, the durability of the structure is also an important parameter which should be taken care of. In fact the cube strength only indicates the strength of the structure at the time of construction whereas the durability is the long term guarantee of same strength and servicesibility of the structure. Corrosion of reinforcement steel and carbonation of concrete are the main culprits responsible for the menace for durability.

#### **Mechanism of Corrosion**

Concrete provides an ideal protective environment to steel from corrosion. Due to high initial alkalinity, an extremely thin passive film of ferric-oxide ( $\text{Fe}_2\text{O}_3$ ) is automatically formed on the surface of steel. This layer, though extremely thin, effectively protects the steel from corrosion. But unfortunately this layer is effective as long as the surrounding remain alkaline. Therefore, if we can manage to keep the environment alkaline, the corrosion of steel can effectively be prevented and the durability of the





reinforcement and the passive film of ferric-oxide is destroyed. All these enemies attacking the concrete are shown in **Fig-1**.

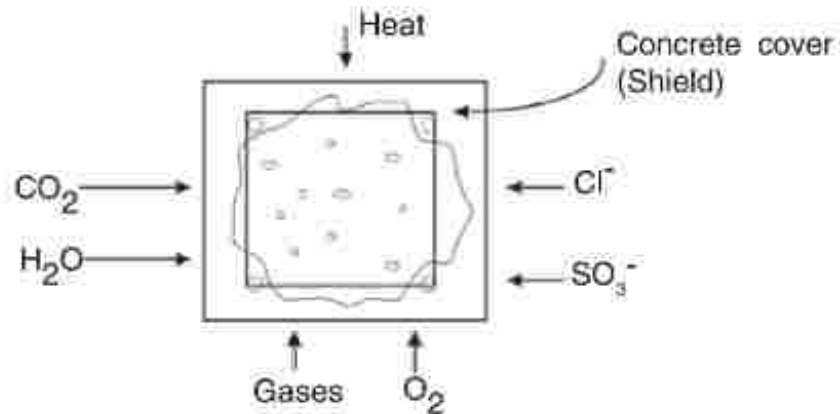

**Fig-1 Enemies attacking concrete**

Now the steel surface becomes active acting as anode and the other inactive surface becomes cathode. Due to this development the electro-mechanical reaction starts as shown in **Fig-2**.

At Anode



At Cathode

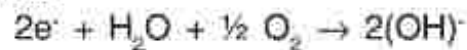

At Anode

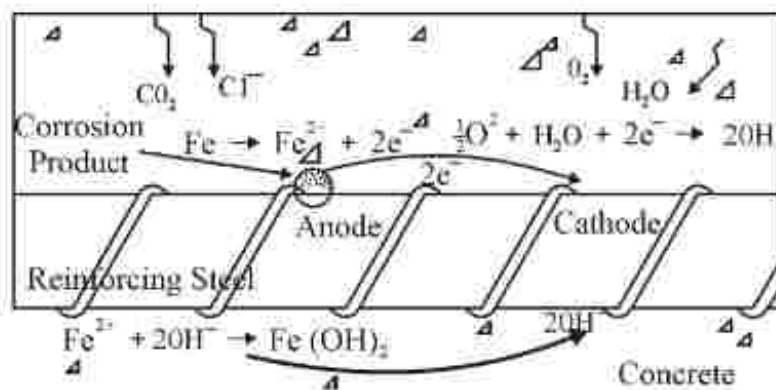
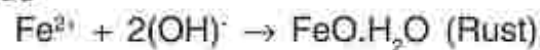

**Fig-2 Electro-chemical Process of Corrosion**

These reactions can take place when concrete is permeable and allow oxygen, moisture,  $\text{CO}_2$ ,  $\text{SO}_3^-$  and Cl etc. to reach up to reinforcement. Further oxidation of rust also takes place and its volume progressively increases with each level of oxidation. Finally the volume of rust becomes nearly 6 times the volume of steel oxide layer, as shown in **Table-1** which obviously can't be accommodated in the set concrete and cracking and spalling of concrete is eventually started.

**Table-1**

Different Levels of oxidation	$\text{FeO}$	$\text{Fe}_3\text{O}_4$	$\text{Fe}_2\text{O}_3$	$\text{Fe}(\text{OH})_2$	$\text{Fe}(\text{OH})_3$	$\text{Fe}(\text{OH})_3 \cdot 3\text{H}_2\text{O}$
Volume	1	2	3	4	5	6

It can be concluded from the above discussion that if the concrete is made impermeable and supply of various agents which are responsible for the reaction are effectively prevented from reaching the reinforcement then the process of rusting will automatically be avoided.

### Process of Carbonation

Carbonation is the reaction of  $\text{CO}_2$  with hydrated concrete. Due to this reaction the alkaline nature of concrete gets neutralised and it pave the way for corrosion of reinforcement. The most common method to detect carbonation is to spray a cut or broken concrete section with a phenolphthalein alcoholic solution. The solution remains clear on carbonated concrete, but turns pink at non-carbonated areas. The test is actually an indicator of pH of concrete surfaces, but because carbonation reduces pH, this test also provides an indirect indication of carbonation. This reaction starts at the surface of the concrete and penetrates into the concrete. The rate of penetration depends upon the permeability of concrete. The

time taken for carbonation to reach the level of reinforcement depends upon permeability as well as the cover of concrete.

$$D = k \sqrt{t} \text{ or}$$
$$t \propto D^2$$

where  $t$  = concrete exposure time to  $\text{CO}_2$ ,  
 $D$  is depth of carbonation and  
' $k$ ' is a carbonation constant.

If the cover is more, the carbonation time will also be more. The factor ' $t$ ' depends upon concrete permeability. The importance of permeability of concrete has been realised in Indian Railways also and now by correction slip No.1 to 'Concrete Bridge Code', the permeability test has been made mandatory for all major bridges in all exposure conditions and for all RCC/PSC bridges when exposure condition is severe/very severe or extreme. It has further been stipulated that even in mild or moderate exposure condition, it is desirable to conduct permeability test for other than major bridges also. The procedure of permeability test of concrete is as explained below and shown in **Fig-3**.

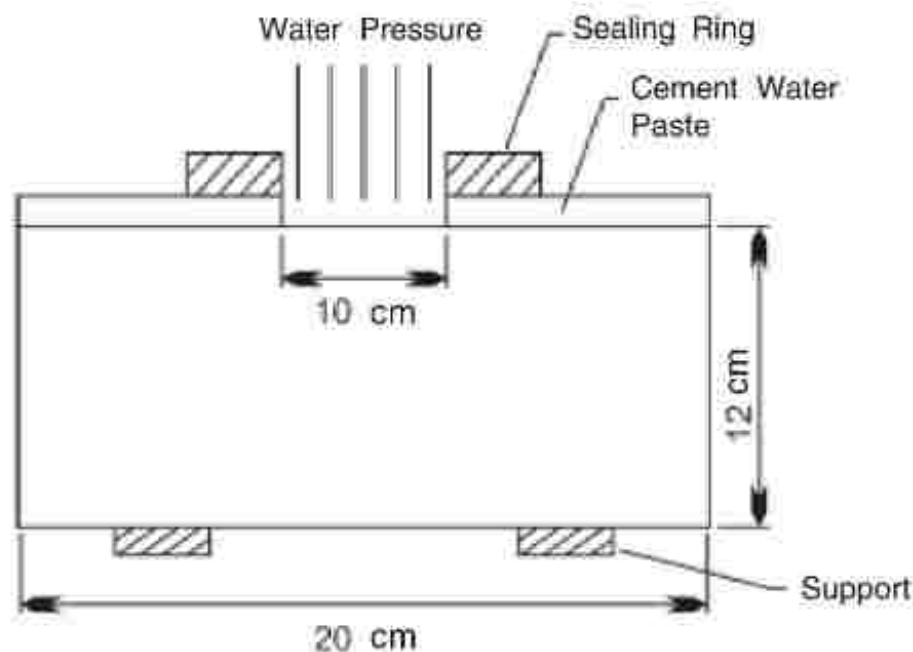

**Fig - 3 Permeability Test**

## Permeability Test

1. Three concrete specimen, each of 200 mm dia and 120 mm height are cast.

2. After 24 hrs, the middle portion of 100 mm dia is roughened and the remaining portion is sealed with cement paste.

3. The specimen are cured for 28 days and then water pressure is applied on the middle roughened portion so that water can penetrate inside the concrete. The water pressure is maintained as given under.

- (a) 1 bar ( $1 \text{ kg/cm}^2$ ) for 48 hours.
- (b) 3 bars for next 24 hours
- (c) 7 bars for next 24 hours.

4. After this, the specimen are split to know the penetration of water. The specimen are split in compression machine by applying concentrated load at two diagonally opposite points slightly away from central axis. The average of three maximum values of penetration is calculated. The depth of penetration of water should not be more than 25 mm otherwise the specimen are considered to be failed in permeability test.

Permeability of concrete can be minimized by adopting low w/c ratio, ensuring proper compaction and curing of concrete as shown in the **Table-2**.

**Table-2**

w/c ratio	Coefficient of Permeability
0.32	$1 \times 10^{-3}$
0.50	$10 \times 10^{-3}$
0.65	$100 \times 10^{-3}$

## Good Construction Practices

In order to improve the workmanship of concrete, the following good practices be adopted in the field :

1. To prevent leakage of cement slurry through shutter plate joints, 10 mm thick sponge should be used.
2. Cover block should have the comparable strength, durability and permeability as that of main concrete.
3. Sequencing of concrete work should be finalised in advance so that the first layer does not set before the next layer is placed over it. This can be ensured by carefully planning the following items :
  - (a) Capacity of mixers
  - (b) Initial Setting Time of cement
  - (c) Man power to be deputed
4. Cold joints should be avoided by forward flowing method of concreting as shown in **Fig-4**.

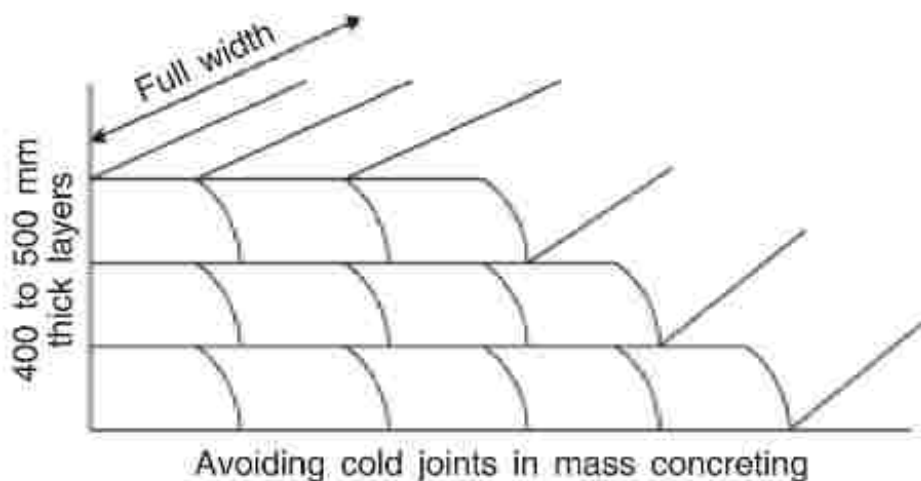

**Fig - 4 Step Placing in Concrete**

5. Provide proper construction joint at the end of days work. Lattice of cement, which has risen up to the surface due to vibration, should be removed before next days' concreting because it is highly permeable. It should be removed by wire brush and aggregates should be exposed without dislodging in such a manner that 1/3 of aggregates should be visible on the surface. This is called 'Hacking of joints'. Never sprinkle cement slurry before next days' concrete.

6. For important structures, full scale mock-up trial should be conducted to test the working of equipments, cover, behaviour of plasticizers, workability and the final product.

### **Conclusion**

Durability of concrete structures has agitated the mind of civil engineers in eighties of last century. Till now the engineers were pre-occupied mainly with strength. Durability is closely related with an important process called compaction. The strength as well as durability get drastically reduced if compaction is not fully ensured in the concrete. To feel the gravity of the situation, we can imagine how inadequate compaction even in a smaller part of the structure may render the entire structure weak and un durable. Therefore, it is necessary that compaction should be ensured throughout the structure with equal precision. This can be ensured in a better way if human element is minimized which has greatly been achieved by using 'Self Compacting Concrete'. **Fig-5** shows the effect of w/c ratio and compaction on strength of concrete.



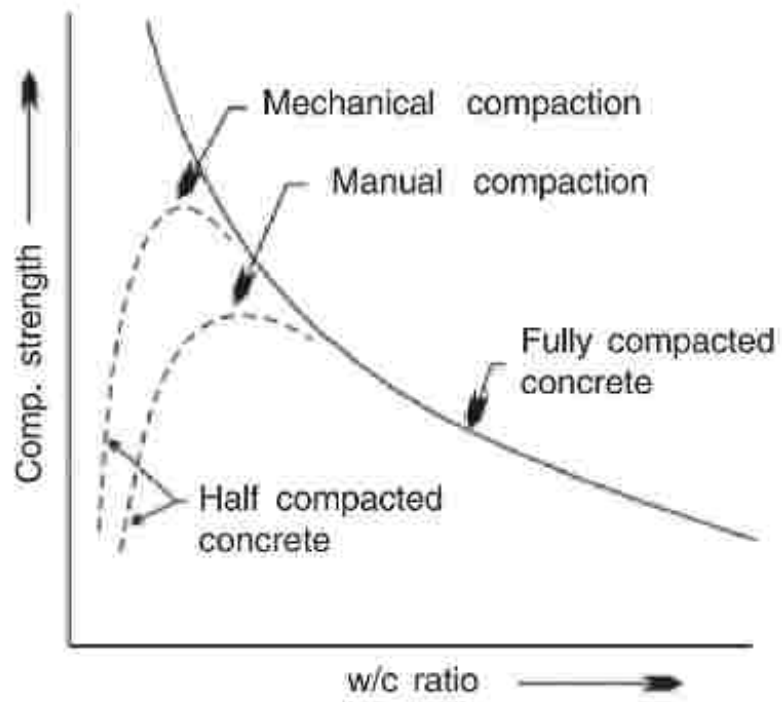

**Fig - 5 Importance of Compaction**

■ ■ ■

## CHAPTER 8

### HIGH PERFORMANCE CEMENT

The simplistic definition of High Performance Concrete (HPC) can be given as 'Concrete having high workability, high strength and high durability'.

With the development of concrete strength beyond M-120, concrete as a building material has started competing with the strength of ordinary reinforcement steel at least in compression. One major breakthrough responsible for this feat is the use of admixtures i.e. chemical admixture like super-plasticizer and mineral admixtures like fly-ash, blast furnace slag and micro silica. Chemical admixtures increase the strength of concrete by reducing the w/c ratio, whereas mineral admixtures play an important role in increasing the durability of the concrete.

HPC era began with the use of M-50 in the year 1965 for 'Lake Point Tower' in Chicago. After that two 'Union Square' Buildings in Seattle were constructed with M-120 concrete column. Now the use of HPC has become very common the world over.

#### **Role of Mineral Admixtures**

The production of OPC requires a lot of energy and raw material. At the same time a lot of 'green house gases' are emitted during the process, polluting the atmosphere. Blending mineral admixtures with OPC is one step in the direction of eliminating both the above problems. In fact, all the mineral admixtures which are used for blending with cement are the waste products of one or the other industrial processes.

Production of cement is an energy intensive activity. Its energy consumption is highest after steel and aluminium

production. The energy required for one ton of cement is 4 GJ and at the same time it produces 1 ton of CO<sub>2</sub>. Presently India produces more than 120 MT of OPC which means that it consumes at least 480 GJ of energy and releases 120 tons of CO<sub>2</sub> in the atmosphere.

On the other hand, the annual production of waste products like fly-ash and slag are approximately 130 MT and 100 MT respectively. Presently a major portion of these products end up in low-value applications such as land-fill, base course for roads etc. Not only this is a low value application but it is very harmful also because these contain toxic metals which are passed on to land. The toxicity of these materials can be immobilised only by the hydration process in combination with cement.

## **READY MIX CONCRETE**

This is another revolution called 'Ready Mix Concrete' in the history of concrete technology. As the name suggests, it is a concrete which is readily available in the mixed form so that it can directly be placed in the formwork. Therefore, the various processes involved in the conventional concrete are accomplished in the factory condition and therefore much superior concrete is obtained in comparison to conventional concrete. The processes which are done away with are as given below:

- (a) Storage of material
- (b) Proportioning
- (c) Mixing
- (d) Transportation
- (e) Placement

All above processes are taken care of by the producers, who are committed to supply the concrete of desired strength and required properties. Based upon the requirement of the user, the proportioning and mixing is done in the central batching plant and then it is transported to the site of placement on truck mounted rotating drum mixers so that the concrete reaches the destination with the

required properties in green state and a commitment for the desired strength in the hardened state.

### **Truck-mounted Drum Mixer**

These mixers have a revolving drum with the axis inclined to the horizontal. There is a pair of blades, inside the drum, in helical configuration from the head to the opening of the drum. This configuration helps in discharging the concrete when the drum revolves in a particular direction. During the transit period, the drum is continuously turned at a speed of approximately 2 revolutions per minute (rpm).

Traditionally, the truck mounted mixers discharge the material from rear end but now the front discharging units are also becoming popular. In this type of unit the driver of the truck can control the unit in a better way and the concrete can directly be discharged at a desired place without taking help of other personnel.

In addition to transportation, sometimes these mixers are used for mixing the concrete also. The drums are designed for a maximum rated capacity of 63% of the gross drum volume when mixing is also done in the truck mixers otherwise this capacity is generally 80% of the drum volume.

The lead of concrete should be a design parameter because it is a perishable item which may undergo 'slump loss' depending upon temperature and time taken in delivery at the site. Normally, the concrete shall be discharged at the job site within 90 minutes and before 300 revolutions after water has been added to the cement. When the long delivery time and high temperatures are involved, some admixture such as air entraining, water reducing, retarding or high range water reducers are used.

### **Types of Ready Mix Concrete**

There are three types of RMC depending upon the mixing of the various ingredients as given below :

- a) Transit mixed concrete
- b) Shrink mixed concrete
- c) Central mixed concrete

#### **a) Transit Mixed Concrete**

It is also called dry batched concrete because all the basic ingredients including water are charged directly into the truck mixer. The mixer drum is revolved fast at charging speed during the loading of the material and after that it continues rotating at a normal agitating speed. In this type of RMC also, three variations are possible as given below :

##### **(i) Concrete mixed at job site**

While being transported towards the destination, the drum is revolved at a slow or agitating speed of 2 rpm but after reaching the site just before discharging the material, it is revolved at maximum speed of 12 to 15 rpm for nearly 70 to 100 revolution for ensuring homogeneous mixing.

##### **(ii) Concrete mixed in transit**

The drum speed is kept medium during the transit time, i.e. approximately 8 rpm for about 70 revolutions. After 70 revolutions, it is slowed down to agitating speed i.e. 2 rpm till discharging the concrete.

##### **(iii) Concrete mixed in the yard**

The drum is turned at high speed of 12 to 15 rpm for about 50 revolutions in the yard itself. The concrete is then agitated slowly during transit time.

#### **b) Shrink Mixed Concrete**

The concrete is partially mixed in the plant mixer and then balance mixing is done in the truck mounted drum mixer during transit time. The amount of mixing in transit

mixer depends upon the extent of mixing done in the central mixing plant. Tests should be conducted to establish the requirement of mixing in the drum mixer.

### **c) Central Mixed Concrete**

It is also called 'central batching plant' where the concrete is thoroughly mixed before loading into the truck mixer. Sometimes the plant is also referred as 'wet-batch' or 'pre-mix plants'. While transporting the concrete, the truck mixer acts as agitator only. Sometimes when workability requirement is low or the lead is less, non-agitating units or dump trucks can also be used.

### **Advantages of RMC**

1. Reduction in cement consumption by 10-12% due to better handling and proper mixing. Further reduction is possible if mineral admixtures or cementitious materials are used.
2. Since RMC uses bulk cement instead of bagged cement, dust pollution will be reduced and cement will be saved.
3. Conservation of energy and resources because of saving of cement.
4. Environment pollution is reduced due to less production of cement.
5. With better durability of structure, their overall service life of increase and there is a saving in 'Life Cycle Cost'.
6. Quality assurance due to mechanical handling and uniformity of processes.
7. Eliminating or minimising human error and reduction in dependency on labour.
8. General benefits like speedy work, stability of structures etc.

RMC was started in India around the year 1994. RMC is a tailor-made concrete which improves durability and sustainability. Instead of purchasing the raw materials by individuals and experimenting every time with handling and proportioning, it would be a far better idea to entrust all these activities to some expert supplier who is having a professional acumen.

## **SELF COMPACTING CONCRETE**

Self Compacting Concrete (SCC) is a recent development and another feather in the cap of concrete industry. It was first developed in 1988 for eliminating human error associated with compaction and also to make it a labour free activity. In Japan where labour is just not available easily, it was developed as a necessity. Whatever may be the compulsions of developing such a form of concrete, it has proved a boon for durability of concrete. Presently it is being used only in major projects, but shortly it will become a universal phenomenon and it will be used by all just like conventional concrete.

### **Mechanism of Self Compaction**

Before going through the literature on self compacting concrete, it will be interesting to imagine how it may be possible to achieve self compaction without any external vibration. Similarly what may be different requirements with respect to ingredients and what problems may be encountered in achieving self compaction with their possible solutions?

As a layman, the SCC should be something like a flowing concrete which should be able to flow up to every nook and corner of the formwork only under gravity. Is it only increasing the workability of concrete? No. Had it been so, then it would not have been so special about SCC because the workability can merely be increased by increasing the w/c ratio or adding suitable plasticizers. In fact, it is the viscosity of the concrete which needs to be



modified in addition to increasing the workability. In order to achieve this, one more admixture is also added which is called 'Viscosity Modifying Agent' (VMA).

When concrete is expected to reach every corner of the structure only due to its own weight, some problems are sure to be expected. It has to pass through many obstacles in the form of closely spaced reinforcement and sharp corners etc. The concrete reaching the far end after conquering all these obstacles should have the same consistency as that of original concrete. The obstacles should not be able to block the aggregates and pass the cement mortar alone. In other words, the viscosity of the mortar should be sufficient to carry with it all the ingredients of concrete without any segregation.

In addition to above, the normal size of the aggregates and their proportions adopted in conventional concrete are also not suitable for SCC. Since the concrete has to travel through a network of reinforcement which is acting like a sieve, the size of coarse aggregates has to be comparatively smaller and their proportion be reduced. This will help in conquering the blockades smoothly without segregation. Therefore, 'Self Compaction' involves achieving high deformability of mortar so that no segregation occurs when concrete flows through the confined zones of reinforcing bars. The credit for this type of concrete goes to Okamura, Ozawa and Malkawa of Japan.

### **Problems in achieving self compaction**

When concrete is passing through various obstacles, the relative distance between the particles decreases and the frequency of collision and contact between aggregate particles increases as shown in **Fig-1**. Due to this collision, some extra energy is required to maintain the flow. This extra energy requirement can be controlled by limiting the size and content of coarse aggregates because consumption of energy is maximum in coarse aggregates. In addition to this, if the viscosity of the paste is increased, the latent energy stored in the paste in

the form of momentum will be utilised in overcoming the loss of energy.

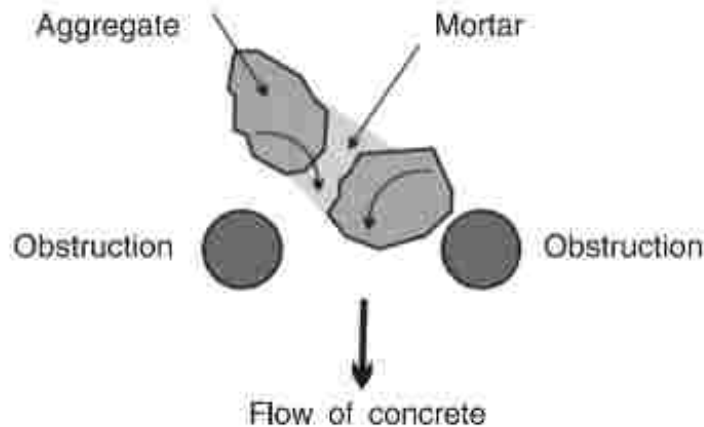

**Fig - 1 Friction between the particles**

The viscosity of the mortar is increased by adding 'Viscosity Modifying Agent' and keeping w/c ratio as low as possible. Due to high viscosity, deformability of paste becomes high and it prevents localised increase in internal stresses due to approach of coarse aggregates towards the obstacles. In order to achieve this, the degree of packing of CA is kept less at approximately 50% to reduce the interaction between CA particle at the time of deformation. Similarly the degree of packing in fine aggregate is also limited to 60% so that shear deformity is controlled.

### **Advantages of SCC**

1. Since concrete is capable of filling the formwork completely under its own weight, there is no requirement of vibration. Full compaction is ensured without making elaborate arrangements of internal or external vibration.

2. There is no need of finishing the green concrete as very good finish is obtained using SCC. Similarly there is no need of repairs to hardened concrete as there are no chances honeycombing.

3. There is a remarkable improvement in the performance and durability of concrete.

4. There is almost no noise pollution as no vibration is required.

5. It is advantageous to use SCC when the normal placement of concrete is difficult e.g. tunnel linings, heavily reinforced structures, PSC structures and other inaccessible places.

### **Requirement of Admixtures**

Two types of admixtures are required for obtaining Self Compacting Concrete.

1. High range water reducing Agents (HRWRA)
2. Viscosity Modifying Agents (VMA)

#### **1. High range water reducing Agents (HRWRA)**

Various types of water reducing agents or super-plasticizers are available in the market as given below :

- (a) Modified lingo-sulphonates
- (b) Melamine-Sulphonates
- (c) Naphthalene-Sulphonates
- (d) Poly-carboxylic Ethers.

Out of the above, Poly-carboxylic Ethers (PCE) are considered most effective. But while using PCE, it needs to be ensured that it is added in the concrete mixer only after initial mixing of all other ingredients. Other three types of super-plasticizers can be added even after mixing with water.

#### **2. Viscosity Modifying Agents (VMA)**

These are added in the concrete for the following purposes:

(a) To reduce bleeding, segregation and retention of water in the skeleton. In short, they improve the stability of the concrete mix.

(b) To reduce creep and shrinkage of SCC. Normally the proportion of fine aggregates in SCC should be increased at the cost of coarse aggregates so that it can perform better while passing through the maze of reinforcement bars. But addition of VMA will enable reducing the requirement of FA to the level of normal concrete. Indirect advantage will be that creep and shrinkage of SCC will be reduced to the normal levels.

### **Use of Mineral Admixtures in SCC**

It has been found from experiments that in order to improve the stability of the mix in SCC and also to prevent segregation and bleeding, fine powder with particle size less than 0.125 mm is required in the range of 400-600 kg/m<sup>3</sup>. OPC has 99% of its particles less than 0.090 mm size and almost 100% smaller than 0.125 mm. Hence OPC qualifies as the primary material for SCC. But the quantity of cement is not sufficient to meet the demand of SCC. Hence in order to fulfil this requirement, supplementary powder materials like fly-ash, blast furnace slag etc. are added in the concrete. Fly-ash has its particle size exactly in the desired range whereas in blast furnace slag, some milling is required. Therefore, fly-ash is the popular mineral admixture, used in SCC particularly in India.

### **Advantages of using fly-ash**

1. It improves workability and at same time reduces permeability
2. It reduces bleeding and segregation.
3. It improves pumping performance of concrete and cohesion of the mix.
4. It improve sulphate resistance of concrete.
5. It reduces heat of hydration and leaching of lime called efflorescence.

## **Tests for Self Compacting Concrete**

Conventional workability tests such as slump cone, compacting factor etc. are not suitable for SCC because these can't detect the tendency of segregation and bleeding. Therefore, different tests are necessary to characterize the suitability of SCC as given under. SCC should have the following abilities :

### **a) Filling ability**

SCC should be able to flow and reach all spaces including sharp corners even up to the farthest ends. It should be able to fill completely all spaces in the formwork under its own weight only.

### **b) Passing ability**

SCC has to pass through a range of closely spaced reinforcement bars and other obstructions like duct etc. There will be a natural tendency of concrete to get blocked because the network of reinforcement will act like a sieve which will try to slow down the movement of concrete. But SCC should be able to pass in the formwork without getting blocked.

### **c) Segregation Resistance**

The SCC should remain homogeneous in composition during the flow. This can happen only if the concrete is not segregated concrete travels with all its ingredients.

Normally three types of tests are conducted for self compacting concrete as given below :

1. U-flow test
2. L-Box Test
3. V-funnel test

### 1. U-flow test

It was developed by the Taisei Group, Japan. In this test, the degree of compatibility can be indicated by the height that the concrete achieves after flowing through a particular obstacle. Concrete with a filling height of over 300 mm can be judged as self compacting. This test has been shown in **Fig-2**.

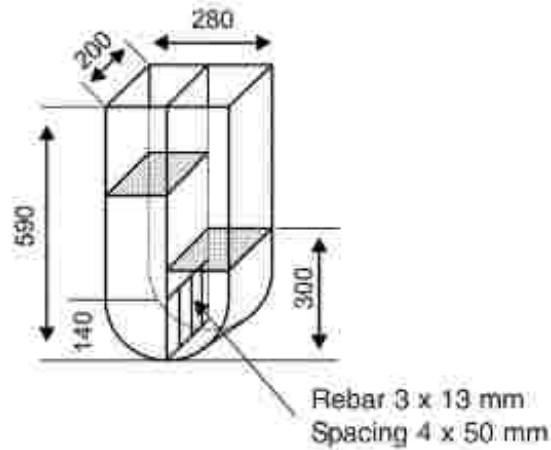
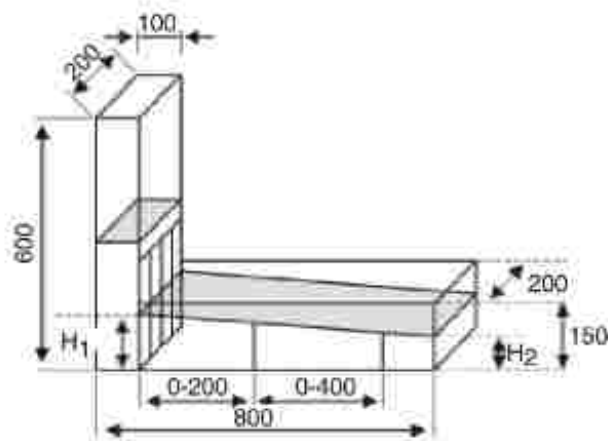

**Fig 2 U - Flow test**

### 2. L-Box Test

It is similar to U-flow test but more suitable for detecting concrete with higher possibility of segregation of coarse aggregates. If the concrete does not have sufficient self compatibility then the reason has to be ascertain quantitatively and the mix proportion will be adjusted. In this test, concrete is poured in the vertical column and allowed to pass through the opening of height  $H_1$  as shown in **Fig-5**. The height of concrete at the other end will give an idea about passing ability of concrete.

$$\text{Passing ratio} = \frac{H_2}{H_1}$$



**Fig-3 L - Box Test**

### 3. V - Funnel test

In this test, concrete is poured in a rectangular shape funnel which is having top dimension of 515 mm x 75 mm and bottom dimension as 65 mm x 75 mm. Its total height is 600 mm out of which 150 mm bottom portion is straight as shown in **Fig-4**. The concrete comes out from bottom where some obstruction is also provided. Funnel is filled-up completely with concrete and then bottom door is opened. The time required for entire concrete to flush out is called V-flow time.

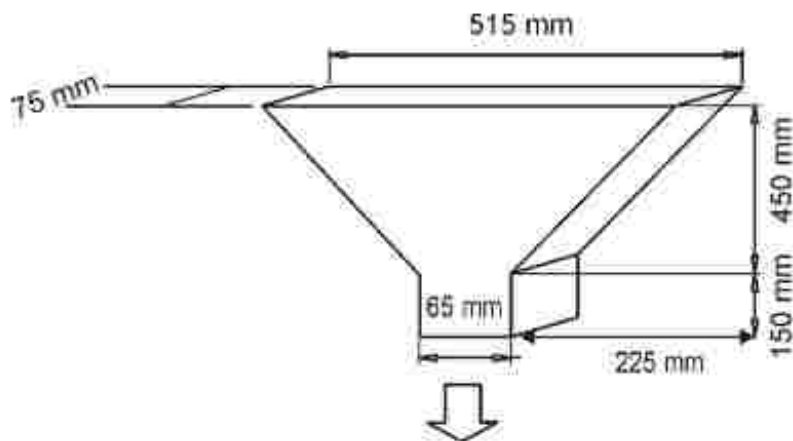

**Fig-4 V - Funnel Test**



## **Popularity of SCC in India**

SCC has already come out of laboratory and reached the fields. Presently it is being used in important structures only, but it is likely to become very popular for the common structures also. It has now been established as a proven technology. In India, so far it has been successfully used in many projects as given like :

- (a) Delhi Metro Rail Corporation
- (b) Tarapur Atomic Power Project
- (c) Bandra Worli Sea Link Project
- (d) Kaiga Atomic Power Project
- (e) Rajasthan Atomic Power Project

## **Cost Comparison**

There is a general impression that SCC may be very costly as compared to the conventional concrete. In fact it is partially true as it is slightly costlier due to the use of high range 'super-plasticizers' and 'viscosity modifying agents'. For a mix of M-40 the cost of SCC may be approximately 15-20% higher. But considering the fact that vibration is not required when SCC is used, this extra cost is offset to some extent and in many cases it may even become cheaper than conventional concrete.

## **VACUUM CONCRETE**

It is a well known fact that excessive w/c ratio is detrimental for concrete. We always try to restrict the w/c ratio in order to achieve higher strength. The chemical reaction of cement with water requires a w/c ratio of less than 0.38, whereas the adopted w/c ratio is generally much more than that mainly because of the requirement of workability. Workability is also important for concrete, so that it can be placed in the formwork easily without honeycombing .

After the requirement of workability is over, this excess water will eventually evaporate leaving capillary pores in the concrete. These pores result into high permeability and less strength in the concrete. Therefore, workability and high strength don't go together as their requirements are contradictory to each other.

Vacuum concreting is the effective technique used to overcome this contradiction of opposite requirements of workability and high strength. With this technique both these are possible at the same time.

In this technique, the excess water after placement and compaction of concrete is sucked out with the help of vacuum pumps. This technique is effectively used in industrial floors, parking lots and deck slabs of bridges etc. The magnitude of applied vacuum is usually about 0.08 MPa and the water content is reduced by upto 20-25%. The reduction is effective up to a depth of about 100 to 150 mm only.

### **Technique and Equipments**

The main aim of the technique is to extract extra water from concrete surface using vacuum dewatering. As a result of dewatering, there is a marked reduction in effective w/c ratio and the performance of concrete improves drastically. The improvement is more on the surface where it is required the most.

Mainly four components are required in vacuum dewatering of concrete, which are given below:

- (1) Vacuum pump
- (2) Water separator
- (3) Filtering pad
- (4) Screed board vibrator

Vacuum pump is a small but strong pump of 5 to 10 H.P. Water is extracted by vacuum and stored in the water separator. The mats are placed over fine filter pads, which

prevent the removal of cement with water. Proper control on the magnitude of the applied pressure is necessary. The amount of water removed is equal to the contraction in total volume of concrete. About 3% reduction in concrete layer depth takes place. Filtering pad consists of rigid backing sheet, expanded metal, wire gauge or muslin cloth sheet. A rubber seal is also fitted around the filtering pad as shown in **Fig-5**. Filtering pad should have minimum dimension of 90 cm x 60 cm.

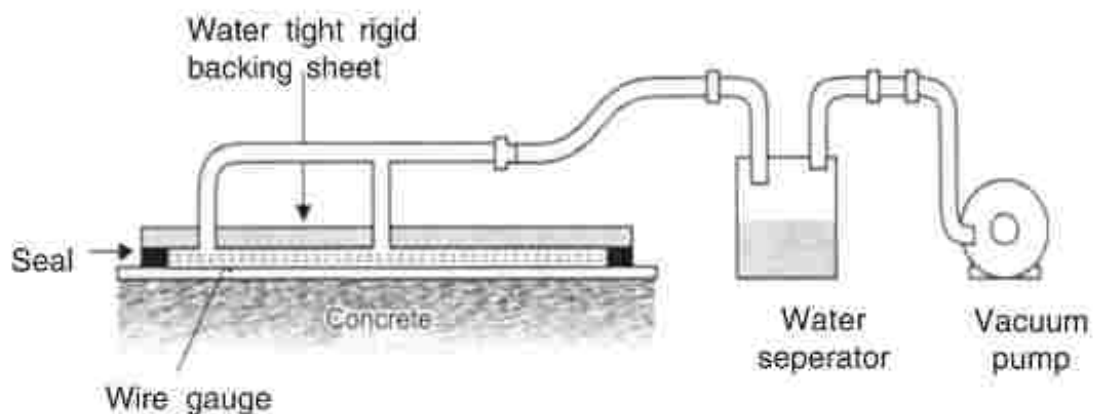
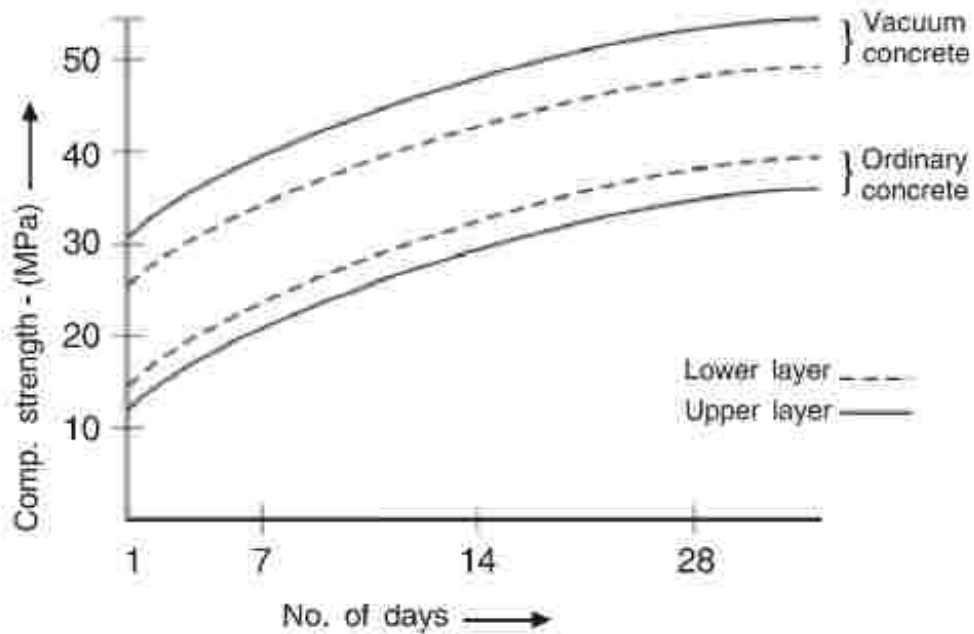

**Fig - 5 Vacuum Dewatering**

#### **Advantages of vacuum concreting**

1. Due to dewatering through vacuum, both workability and high strength are achieved simultaneously.
2. Reduction in w/c ratio may increase the compressive strength by 10 to 50% and lowers the permeability.
3. It enhances the wear resistance of concrete surface.
4. The surface obtained after vacuum dewatering is plain and smooth due to reduced shrinkage.
5. The formwork can be removed early and surface can be put to use early.

However, the advantages of vacuum dewatering are more prominent on the top layer as compared to bottom layer as shown in **Fig-6**. The effect beyond a depth of 150 mm is negligible.



**Fig - 6 Effect of de-watering**

■ ■ ■

## REFERENCES

1. RDSO Report : BS-14
2. Journal 'Concrete International' June 2007, Article 'Statistical Acceptance Criteria for Strength of Mass Concrete' by Ernest Schrader.
3. M.S. Shetty, "Concrete Technology – Theory and Practice", S. Chand.
4. A.M. Nivelle, "Properties of Concrete", ELBC with Longman.
5. S.G. Bapat, Chief Engineer, EPC Mumbai, "Application of SCC : Case Studies".
6. "Specifications and Guidelines for Self Compacting Concrete" – Issued by EFNARC February 2002.
7. Tremix, Nordic Construction Equipment, AB Sweden.
8. Gujarat Ambuja Cements Ltd., Technical Services Division, Mumbai.
9. Hazime Okamura and Masahiro Ouchi's paper 'Self Compacting Concrete' in journal of Advanced Concrete Technology, Vol.1, No. 1, 5-15, April 2003/copyright ©2003 Japan Concrete Institute.

*Edited and Published by*  
**INDIAN RAILWAYS INSTITUTE OF CIVIL ENGINEERING, PUNE**

*Typeset & printed by :*  
**M. R. & Co.**

---

**Price Rs. 50/-**