

BHARAT INSTITUTE OF ENGINEERING AND TECHNOLOGY

(Approved by AICTE Affiliated to SCTE & VT)

Sivaram Vihar, Ghatakeswar Hills, Mohada, Berhampur, Odisha.

PIN-760002



LECTURE NOTES

ON

Element of Mechanical Engineering

(Electrical 3rd Semester)

Prepared By

Er. Satyanarayan Pradhan

DEPARTMENT OF ELECTRICAL ENGINEERING

BIET, MOHADA, BERHAMPUR



<http://www.biet.edu.in/>

ELEMENTS OF MECHANICAL ENGINEERING

CHAPTER- 1

1.1. Thermodynamics

The heat is defined as the energy transferred, without transfer of mass, across the boundary of a system because of a temperature difference between the system and the surroundings. It is usually represented by Q and is expressed in Joule (J) or Kilo-Joule (KJ).

Work

Work is defined as the product of the force (F) and the distance moved (X) in the direction the force. Mathematically, work done, $W = F \times X$,

The unit of work depends upon the unit of force and the distance moved. In S.I. system of units, the practical unit of work is Newton-metre (N-m). The work of 1N-m is known as Joule such that $1\text{N-m} = 1\text{J}$.

1st law of thermodynamics : This law may be stated as follow :

(a) The heat and mechanical work are mutually convertible. According to this law, when a closed system undergoes a thermodynamic cycle, the net heat transfer is equal to the net work transfer. In other words, the cyclic integral of heat transfers is equal to the cyclic integral of work transfers, mathematically, $\oint \delta Q = \oint \delta W$

Where symbol \oint stands for cyclic integral, and δQ , δW represent infinitesimal elements of heat and work transfers respectively.

(b) The energy can neither be created nor destroyed though it can be transferred from one form to another. According to this law, when a system undergoes a change of state, then both heat transfer and work transfer takes place. The net energy transfer is stored within the system and is known as stored energy or total energy of the system. Mathematically $\delta Q - \delta W = dE$

The symbol δ is used for a quantity which is inexact differential and symbol d is used for a quantity which is an exact differential. The quantity E is an extensive property and represents the total energy of the system at a particular state.

1.2 State Laws of perfect gas.

The physical properties of a gas are controlled by the following three variables :

1. Pressure exerted by the gas
2. Volume occupied by the gas
3. Temperature of the gas

The behaviour of a perfect gas, undergoing any change in the above mentioned variables, is governed by the following laws which have been established from experimental results.

1. Boyle's Law
2. Charles's Law
3. Gay-Lussac Law

1. Boyle's Law

This law was formulated by Robert Boyle in 1662. It states, "The absolute pressure of a given mass of a perfect gas varies inversely as its volume, when the temperature remains constant".

Mathematically, $p \propto \frac{1}{V}$ or $pV = \text{constant}$

2. Charles's Law

This law was formulated by a Frenchman A.c. Charles in about 1787. It may be stated in the following two different forms :

(i) The volume of a given mass of a perfect varies directly as its absolute temperature, when the absolute pressure remains constant". Mathematically, $V \propto T$ or $\frac{V}{T} = \text{constant}$

3. Gay-Lussac Law

This law states, "The absolute pressure of a given mass of a perfect gas varies directly as its absolute temperature when the volume remains constant". Mathematically $p \propto T$ or $\frac{P}{T} = \text{constant}$

1.3 Specific heats of a gas

The specific heat of a substance may be broadly defined as the amount of heat required to raise the temperature of its unit mass through one degree. All the liquids and solids have one specific heat only. But a gas can have any number of specific heats (lying between zero and infinity) depending upon the conditions, under which it is heated. The following two types of specific heats of a gas are important from the subject point of view.

1. Specific heat at constant volume
2. Specific heat at constant pressure

Specific heat at constant volume

It is the amount of heat required one to raise the temperature of a unit mass of gas through one degree when it is heated at a constant volume. It is generally denoted by C_v .

Consider a gas contained in a container with a fixed lid as shown in the figure. Now, if this gas is heated, it will increase

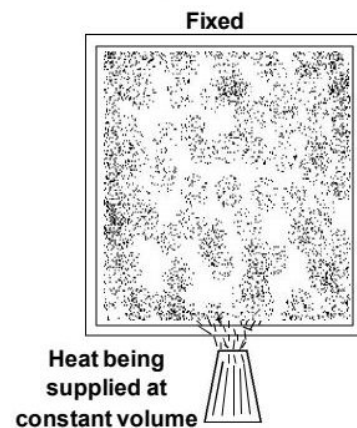

the temperature and pressure of the gas in the container. Since the lid of the container is fixed, therefore the volume of gas remains unchanged.

Let m = Mass of the gas

T_1 = Initial temperature of the gas

T_2 = Final temperature of the gas

Total heat supplied to the gas at constant volume Q_{1-2} = mass \times supplied heat at constant volume \times rise in temperature = $mC_v (T_2 - T_1)$.

It may be noted that whenever a gas is heated at constant volume, no work is done by the gas. The whole heat energy is utilised in increasing the temperature and pressure of the gas.

Specific heat at constant pressure

It is the amount of heat required to raise the temperature of a unit mass of a gas through one degree, when it is heated at constant pressure. It is generally denoted by C_p .

Consider a gas contained in a container with a movable lid as shown in figure. Now if this gas is heated, it will increase the temperature and pressure of the gas in container. Since the lid of the container is movable, therefore it will move upwards in order to counter balance the tendency for pressure to rise.

Let

m = Mass of the gas

T_1 = Initial temperature of the gas

V_1 = Initial volume of the gas

T_2, V_2 = Corresponding values for the final condition of the gas

\therefore Total heat supplied to the gas, at constant pressure.

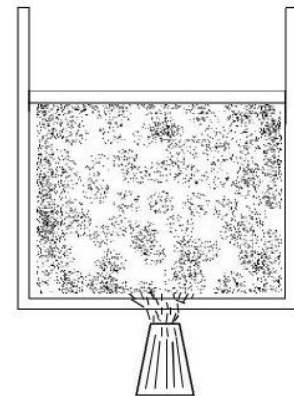

Heat being supplied at constant pressure

Q_{1-2} = Mass \times Sp. heat at constant pressure \times rise in temperature = $mC_p (T_2 - T_1)$.

Whenever a gas is heated at a constant pressure, the heat supplied to the gas is utilised for the following two purposes.

1. To raise the temperature of the gas. The heat remains within the body of the gas and represents the increase in internal energy. $dU = mC_v (T_2 - T_1)$.

2. To do some external work during expansion. Mathematically, work done by the gas $W_{1-2} = P(V_2 - V_1) = mR (T_2 - T_1)$.

Relationship between specific heats

Consider a gas enclosed in a container and being heated, at a constant pressure, from the initial state 1 to the final state 2.

m = Mass of the gas

T_1 = Initial temperature of the gas

T_2 = Final temperature of the gas

V_1 = Initial volume of the gas

V_2 = Final volume of the gas

C_p = Specific heat at constant pressure

C_v = Specific heat at constant volume

P = Constant pressure

We know that heat supplied to the gas at constant pressure

$$Q_{1-2} = mC_p (T_2 - T_1)$$

A part of this heat is utilised in doing the external work, and the rest remains within the gas and is used in increasing the internal energy of the gas.

$$\therefore \text{Heat utilised for external work } W_{1-2} = P(V_2 - V_1) \dots\dots\dots (i)$$

$$\text{And increase in internal energy } dU = mC_v(T_2 - T_1) \dots\dots\dots (ii)$$

$$\text{We know that } Q_{1-2} = W_{1-2} + dU \dots\dots\dots (iii)$$

$$\therefore mC_p(T_2 - T_1) = P(V_2 - V_1) + mC_v(T_2 - T_1) \dots\dots\dots (iv)$$

Using characteristic gas equation (i.e. $Pv = mRT$), we have

$$PV_1 = mRT_1 \dots\dots\dots (\text{for initial condition})$$

$$PV_2 = mRT_2 \dots\dots\dots (\text{for final condition})$$

$$\therefore P(V_2 - V_1) = mR(T_2 - T_1)$$

$$\text{Now substituting the value of } P(V_2 - V_1) \text{ in equation } \dots\dots\dots (v)$$

$$mC_p(T_2 - T_1) = mR(T_2 - T_1) + mC_v(T_2 - T_1)$$

$$\therefore C_p = R + C_v \text{ or } C_p - C_v = R \dots\dots\dots (vi)$$

The above equation may be rewritten as

$$C_p - C_v = R \text{ or } C_v (\gamma - 1) = R \left[\gamma = \frac{C_p}{C_v} \right]$$

$$C_v = \frac{R}{\gamma - 1} \dots\dots\dots (vii)$$

The equation (v) gives an important result as it proves that characteristic constant of a gas (R) is equal to the difference of its two specific heats i.e. ($C_p - C_v$).

CHAPTER - 2.0

i. Wet steam

When the steam contains moisture or particles of water in suspension, it is said to be wet steam. It means that evaporation of water is not complete and the whole of the latent heat has not been absorbed. The enthalpy of wet steam is given by: $h = h_f + Xh_{fg}$ where x is the dryness fraction of steam.

ii. Dry saturated steam

When the wet steam is further heated and it does not contain any suspended particles of water, it is known as dry saturated steam. The dry saturated steam has absorbed its full latent heat. The enthalpy of dry saturated steam is given by: $h = h_g = h_f + h_{fg}$ where dryness fraction $X = 1$.

iii. Superheated steam

When the dry steam is further heated at a constant pressure this rising its temperature, it is said to be superheated steam since the pressure is constant, therefore the volume of superheated steam increases.

The total heat required for the steam to be superheated is

$h_{sup} = \text{total heat for dry steam} + \text{heat for superheated steam}$

$$= h_f + h_{fg} + C_p(t_{sup} - t) = h_g + C_p(t_{sup} - t)$$

Where $C_p =$ mean specific heat at constant pressure for superheated steam.

$t_{sup} =$ temperature of the superheated steam.

$t =$ saturation temperature at the given constant pressure.

The difference ($t_{sup} - t$) is known as degree of superheat.

Steam table and their uses

The properties of dry superheat steam like its temperature of formation (saturation temperature), sensible heat, latent heat of vaporisation, enthalpy or total heat, specific volume, entropy etc., vary with pressure and can be found by experiments only. These properties have been carefully determined and made available in a tabular form known as steam tables.

CHAPTER-3.0

STEAM BOILERS

Introduction

A steam generator or boiler, usually, a closed vessel made of steel. Its function is to transfer the heat produced by the combustion of fuel (solid, liquid or gaseous) to water, and ultimately to generate steam. The steam produced may be supplied :

1. To an external combustion engine, i.e. steam engines and turbines.
2. At low pressures for industrial process work in cotton mills, sugar factories, breweries, etc, and
3. For producing hot water, which can be used for heating installations at much lower pressures.

3.1. Classification of steam boilers.

Though there are many classification of steam boilers, yet the following are important from the subject point of view :

1. **According to the contents in the tube.** The steam boilers, according to the contents in the tube may be classified as :

- (a) Fire tube or smoke tube boiler and
- (b) Water tube boiler.

In fire tube steam boilers, the flames and hot gases, produced by the combustion of fuel, pass through the tubes (called multi-tubes) which are surrounded by water. The heat is conducted through the walls of the tubes from the hot gases to the surrounding water. Examples of fire tube boilers are : Simple vertical boiler, Cochran boiler, Lancashire boiler, Cornish boiler, Scotch marine boiler, Locomotive boiler and Velcon boiler.

In water tube steam boilers, the water is contained inside the tubes (called water tubes) which are surrounded by flames and hot gases from outside. Examples of water tube boilers are : Babcock and Wilcox boiler, Stirling boiler, La-Mont boiler, Benson boiler, Yarrow boiler and Loeffler boiler.

2. **According to the position of the furnace.** The steam boilers, according to the position of the furnace are classified as :

- (a) Internally fired boilers, and
- (b) Externally fired boilers

In internally fired steam boilers, the furnace is located inside the boiler shell. Most of the fire tube steam boilers are internally fired.

In externally fired steam boilers, the furnace is arranged underneath in a brick-work setting. Water tube steam boilers are always externally fired.

3. **According to the axis of the shell.** The steam boilers, according to the axis of the shell, may be classified as :

- (a) Vertical boilers and
- (b) Horizontal boilers.

In vertical steam boilers, the axis of the shell is vertical. Simple vertical boiler and Cochran boiler are vertical boilers.

In horizontal steam boilers, the axis of the shell is horizontal. Lancashire boiler, Locomotive boiler and Babcock and Wilcox boiler are horizontal boilers.

4. **According to the number of tubes.** The steam boilers, according to the number of tubes, may be classified as :

- (a) Single tube boilers and
- (b) Multi tubular boilers

In single tube steam boilers there is only one fire tube or water tube. Simple vertical boiler and Cornish boiler are single tube boilers.

In Multitubular steam boilers, there are two or more fire tubes or water tubes. Lancashire boiler, Locomotive boiler, Cochran boiler, Babcock and Wilcox boiler are multitubular boilers.

5. **According to the method circulation of water and steam.** The steam boilers, according to the method of circulation of water and steam, may be classified as :

- (a) Natural circulation boilers, and
- (b) Forced circulation boilers.

In natural circulation steam boilers, the circulation of water is by natural convection currents, which are set up during the heating of water. In most of the steam boilers, there is a natural circulation of water.

In forced circulation steam boilers, there is a forced circulation of water by a centrifugal pump driven by some external power. Use of forced circulation is made in high pressure boilers such as La-Mont boiler, Benson boiler, Loeffler boiler and Velcon boiler.

6. **According to the use.** The steam boilers, according to their use, may be classified as

- (a) Stationary boilers, and
- (b) Mobile boilers

The stationary steam boilers are used in power plants, and in industrial process work. These are called stationary because they do not move from one place to another.

The mobile steam boilers are those which move from one place to another. These boilers are locomotive and marine boilers.

7. **According to the source of the heat.** The steam boilers may also be classified according to the source of heat supplied for producing steam. The sources may be the combustion of solid, liquid or gaseous fuel, hot waste gases as by-products of other chemical processes, electrical energy or nuclear energy etc.

3.2. Cochran Boiler or Vertical Multitubular Boiler

These are various designs of vertical multitubular boilers, A Cochran boiler is considered to be one of the most efficient type of such boilers. It is an improved type of simple vertical boiler.

This boiler consists of an external cylindrical shell and a fire box as shown in Fig.3.1 The shell and fire box are both hemispherical. The hemispherical crown of the boiler shell gives pressure of steam and strength to withstand the pressure of steam inside the boiler. The hemispherical crown of the fire box is also advantageous for resisting intense heat. The fire box and the combustion chamber is connected through a short pipe. The flue gases from the combustion chamber flow to the smoke box through a number of smoke tubes. Then tubes generally have 62.5 mm external diameter and are 165 in number. The gases from the smoke box pass to the atmosphere through a chimney. The combustion chamber is lined with fire bricks on the shell side. A manhole near the top of the crown on the shell is provided for cleaning.

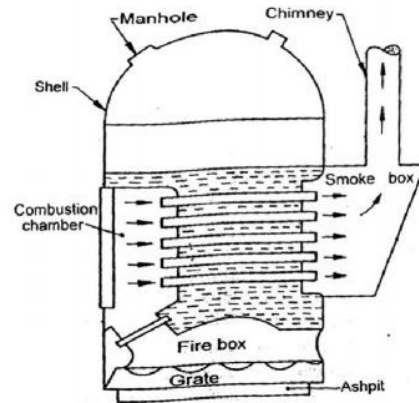

Fig. 3.1 Cochran Boiler

At the bottom of the fire box, there is a grate (in case of coal firing) and the coal is fed through the fire hole. If the boiler is used for oil firing, no grate is provided, but the bottom of the fire box is lined with firebricks. The oil burner is fitted at the fire hole.

3.2.1. Babcock and Wilcox Boiler

It is a straight tube, stationary type water tube boiler, as show in Fig.3.2 It consist of a stem and water drum (1). It is connected by a short tube with uptake header or riser (2) at the back end.

The water tubes (5) (100mm diameter) are inclined to the horizontal and connects the uptake head to the down take header. Each row of the tubes is connected with two headers, and there are plenty of such rows. The headers are curved when viewed in the direction of tubes so that one tube is not in the space of other, and hot gases can pass properly after heating all the tubes. The headers are provided with hand holes in the front of the tubes and are covered with caps (18).

A mud box (6) is provided with each down take header and the mud, that settles down is removed. There is slow moving automatic chain grate on which the coal is fed from the hopper (21). A fire bricks baffle causes hot gases to move upwards and downwards and again upwards

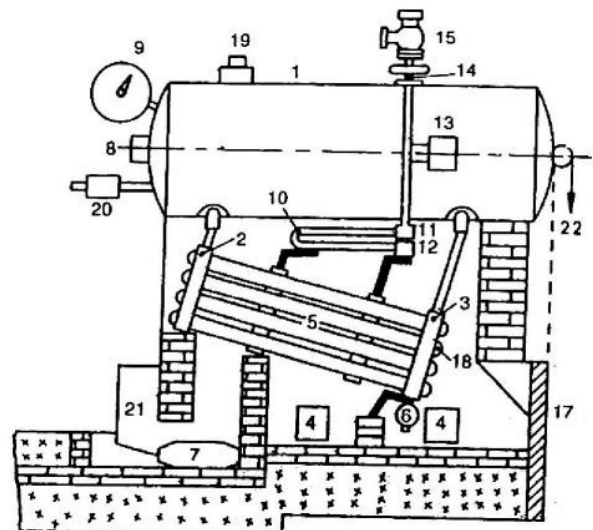

Fig. 3.2 Babcock and Wilcox Boiler

before entering shell by a chain (22) which passes over a pulley to the boiler is suspended on steel girders, and surrender on all the four sides by fire brick walls. The doors (4) are provided for a man

to enter the boiler for repairing and cleaning. Water circulates from the drum (1) into the header (2) and through the tubes (5) to header (3) and again to the drum. Water continues to circulate like this till it is evaporated. A steam superheater consists of a large number of steel tubes (1) and contains two boxes; one is superheated steam box (11) and other is saturated steam box (12).

The steam generated above the water level in the drum flows in the dry pipe (13) and through the inlet tubes into the superheated steam box (11). It then passes through the tubes (10) into the becomes superheated. The steam, during the passage through tubes (10), gets further heated and through the outlet pipe (14) to the stop valve (15).

The boiler is fitted with usual mountings, such as safety valve (19), feed valve (20), water level indicator (8) and pressure gauge (9).

3.2.2. Comparison between Water and Fire Tube boilers

Following are the few points of comparison between a water tube and a fire tube boiler.

	Water tube boiler	Fire tube boiler
1.	The water circulates inside the tubes which are surrounded by hot gases from the furnace.	The hot gases from the furnace pass through the tubes which are surrounded by water.
2.	It generates steam at a higher pressure upto 165 bar.	It can generation of steam only up to 24.5 bar.
3.	The rate of generation of steam is high i.e. upto 450 tonnes per hour.	The rate of generation of steam is low, i.e. upto 9 tonnes per hour.
4.	For a given power, the floor area required for the generation of steam is less, i.e. about 5 m ² per tone per hour of steam generation.	The floor area required is more, i.e. about 8m ² per tonne per hour of steam generation.
5.	Overall efficiency with economizer is upto 90%.	Its overall efficiency is only 75%.
6.	It can be transported and erected easily as its various parts can be separated.	The transportation and erection is difficult.
7.	It is preferred for widely fluctuating loads.	It can also cope reasonably with sudden increase in load but for a shorter period.
8.	The direction of water circulation is well defined.	The water does not circulate in a definite direction.
9.	The operating cost is high.	The operating cost is less.
10.	The bursting chance are more.	The bursting chances are less.
11.	The bursting does not produce any destruction to the whole boiler.	The bursting produces greater risk to the damage of the property.
12.	It is used for large power plants.	It is not suitable for large plants.

3.3 Boiler Mountings and Accessories

Introduction

Boiler mountings and accessories are required for the proper and satisfactory functioning of the steam boilers. Now in this chapter, we shall discuss these fittings and appliances which are commonly used these days.

3.3.1. Boiler Mountings

These are the fittings, which are mounted on the boiler for its proper and safe functioning. Though there are many types of boiler mountings, yet the following are important from the subject point of view :

1. Water level indicator
2. Pressure gauge
3. Safety valves
4. Stop valve
5. Blow off cock
6. Feed check valve and
7. Fusible plug

1. Water level indicator

It is important fitting, which indicates the water level inside the boiler to an observer. It is a safety device upon which the correct working of the boiler depends. This fitting may be seen in front of the boiler, and are generally two in number.

A water level indicator, mostly employed in the steam boiler is shown in Fig.3.3. It consists of the cocks and a glass tube. Steam cock C_1 Keeps the glass tube in connection with the steam space. Water cock C_2 Puts the glass tube in connection with the water in the boiler. Drain cock C_3 is used at frequent intervals to ascertain that the steam and water cocks are clear.

In the working of a steam boiler and for the proper functioning of the water level indicator, the steam and water cocks are opened and the drain cock is closed. In this case, the handles are placed in a vertical position as shown in Fig. The rectangular passage at the ends of the glass tube contains two balls.

In case the glass tube is broken, the two balls are carried along its passages to the ends of the glass tube. It is thus obvious, that water and steam will not escape out. The glass tube can be easily replaced by closing the steam and water cocks and opening the drain cock.

When the steam boiler is not working, the bolts may be removed for cleaning. The glass tube is kept free from leaking by means of conical ring and the gland nut.

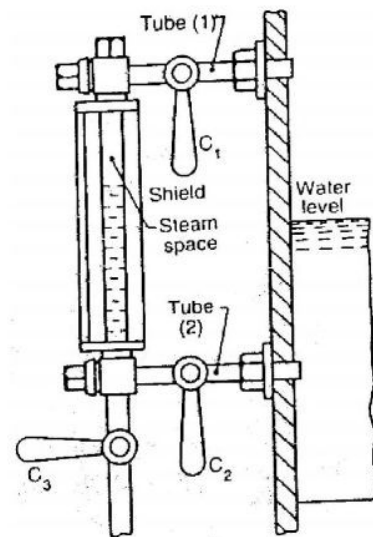

Fig. 3.3 Water level indicator

2. Pressure gauge

A pressure gauge is used to measure the pressure of the steam inside the steam boiler. It is fixed in front of the steam boiler. The pressure gauges generally used are of bourden type.

A bourden pressure gauge, in its simplest form, consists of an elliptical elastic tube ABC bent into an arc of a circle, as shown in Fig. This bent up tube is called bourden's tube.

One end of the tube gauge is fixed and connected to the steam space in the boiler. The other end is connected to a sector through a link. The steam, under pressure, flows into the tube. As a result of this increase pressure, the bourden's tube tends to straighten itself. Since the tube is encased in a circular curve, therefore it tends to become circular instead of straight. With the help of a simple pinion and sector arrangement, the elastic deformation of the bourdens tube rotates the pointer. This pointer moves over a calibrated scale, which directly gives the gauge pressure.

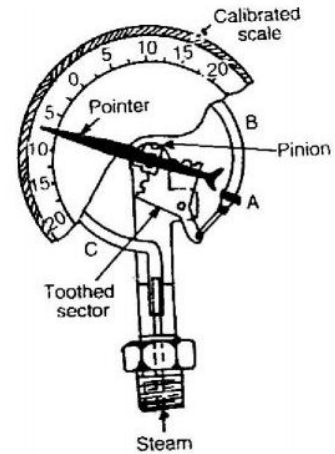

Fig. 3.4 Water level indicator

3. Safety valves

These are the devices to the steam chest for preventing explosions due to excessive internal pressure of steam. A steam boiler is, usually, provided with two safety valves. These are directly placed on the boiler. In brief, the function of a safety valve is to blow off the steam when the pressure of steam inside the boiler exceeds the working pressure. The following are the four types of safety valves :

- (i) Lever safety valve,
- (ii) Dead weight safety valve
- (iii) High steam and low water safety valve
- (iv) Spring loaded safety valve.

It may be noted that the first three types of the safety valves are usually employed with stationary boilers, but the fourth type is mainly used for locomotive and marine boilers.

(i) Lever safety valve

A lever safety valve used on steam boiler is shown Fig. It serves the purpose of maintaining constant safe pressure inside the steam boiler. If the pressure inside the boiler exceeds the designed limit, the valve lifts from its seat and blows off the steam pressure automatically.

A lever safety valve consists of a valve body with a flange fixed to the steam boiler. The bronze valve seat is screwed to the body, and the valve is also made of bronze. It may be noted that by using the valve and seat of the same material, rusting is considerably reduced. The thrust on the valve is transmitted by the strut. The guide keeps the lever in a vertical plane. The load is properly adjusted at the other end of the lever.

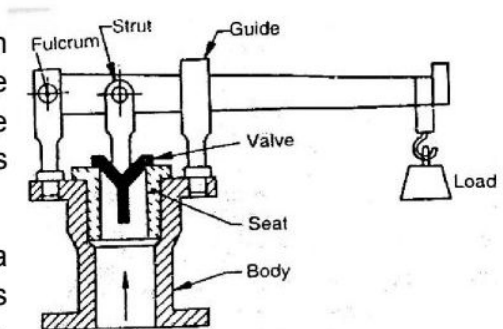

Fig. 3.5 Lever safety valve

(ii) Dead weight safety valve

A dead weight safety valve, used for stationary boilers, is shown in Fig. 3.6 The valve is made of gun metal, and rests on its gun metal seat. It is fixed to the top of a steel pipe. This pipe is bolted to the mountings block, riveted to the top of the shell. Both the valve and the pipe are covered by a case which contains weights. These weights keep the valve on its seat under normal working pressure. The case hangs freely over the valve to which it is secured by means of a nut.

When the pressure of steam exceeds the normal pressure, the valve as well as the case (along with the weights) are lifted up from its seat. This enables the steam to escape through the discharge pipe, which carries the steam outside the boiler house.

The lift of the valve is controlled by the studs. The head of the studs projects into the interior of the casing. The centre of gravity of the dead weight safety valve is considerably below the valve which ensures that the load hangs vertically.

The dead weight safety valve has the advantage that it cannot be readily tempered because any added weight be equal to the total increases pressure of steam on the valve. The only disadvantage of these valves, is the heavy which these valves carry.

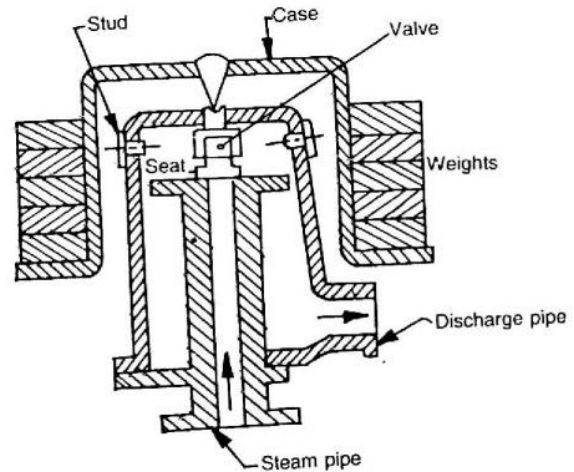

Fig. 3.6 Dead weight safety valve

(iii) High steam and low water safety valve

These valves are placed at the top of Cornish and Lancashire boilers. It is combination of two valves, one of which is the lever safety valve which blows off steam when the working pressure of steam exceeds. The second valve operates blowing off the steam when the water level becomes too low.

A best known combination of high steam low water safety valve is shown in Fig.3.7 It consists of a main valve (known as lever safety valve) and rests on its seat. In the centre of the main valve, a seat for a hemispherical valve is formed for low water operation. This valve is loaded directly by the dead weights attached to the valve by a long rod. There is a lever J,K, which has its fulcrum at K. the lever has weight E suspended at the K. when it is fully immersed in water, it is balanced by a weight F at the other end J of the lever.

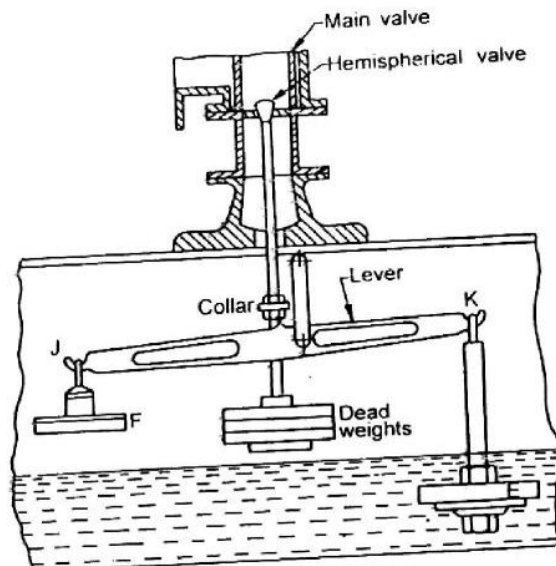

Fig. 3.7 High steam and low water safety valve

When the water level falls, the weight E comes out of water and the weight F will not be sufficient to balance weight E. Therefore weight E comes down. There are two projections on the lever to the left of the fulcrum which comes in contact with a collar attached to the rod. When weight E comes down, the hemispherical valve is lifted up and the steam escapes with a loud noise, which warns the operator. A drain pipe is provided to carry water, which is deposited in the valve casing.

(iv) Spring loaded safety valve.

A spring loaded safety valve is mainly used for locomotives and marine boilers. It is loaded with spring instead of weights. The spring is made of round or square spring steel rod in helical form. The spring may be in tension or compression, as the steam pressure acts along the axis of the spring. In actual practice, the spring is placed in compression.

A Ramsbottom spring loaded safety valve is shown in Fig. 3.8 It is usually, fitted to locomotives. It consists of a cast iron body connected to the top of a boiler. It has two separate valves of the same size. These valves have their seating's in the upper ends of two hollow valve chests. These valve chests are united by a bridge and a base. The base is bolted to a mounting block on the top of a boiler over the fire box.

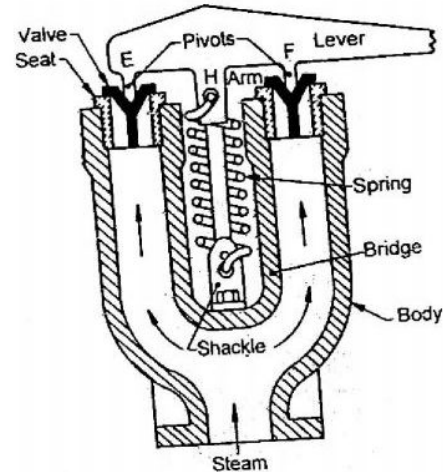

Fig. 3.8 Spring loaded safety valve

The valves are held down by means of a spring and a lever. The lever has two pivots E and F. the pivot E is joined by a pin to the lever, while the pivot F is forged on the lever. These pivots rest on the centre's of the valves. The upper end of the spring is hooked to the arm H, while the lower end of the shackle, which is secured to the bridge by a nut. The spring has two safety links, one behind the other, or one either side of the lever connected by pins at the ends. The lower pin passes through the shackle while the upper one passes through slot in arm H of the lever. The lever has an extension, which projects into the driver's cabin. By pulling or raising the lever, the driver can release the pressure from either valve separately.

4. Steam Stop valve

It is the largest valve on the steam boiler. It is, usually, fitted to the highest part of the shell by means of a flange as shown in Fig. 3.9. The principal functions of a stop valve are :

1. To control the flow of steam from the boiler to the main stream pipe.
2. To shut off the steam completely when required.

The body of the stop valve is made of cast iron or cast steel. The valve, valve seat and the nut through which the valve spindle works, are made of brass or gun metal.

The spindle passes through a gland and stuffing box. The spindle is rotated by means of a hand wheel. The upper

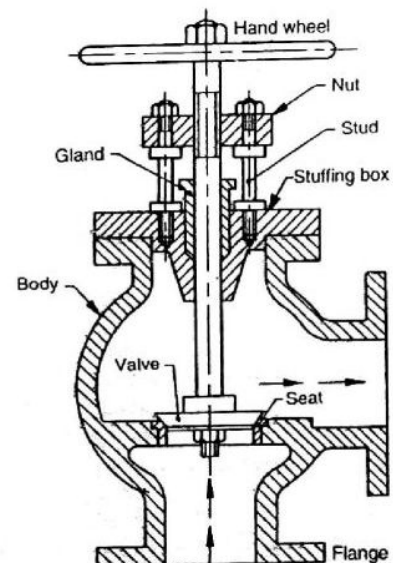

Fig. 3.9 Steam Stop valve

portion of the spindle is screwed and made to pass through a nut in across head carried by two pillars. The pillars are screwed in the cover of the body as shown in the figure. The boiler pressure acts under the valve, so that the valve must be closed against the pressure. The valve is, generally, fastened to the spindle which lifts it up.

A non-return valve is, sometimes, fitted near the stop valve to prevent the accidental admission of steam from other boilers. This happens when a number of boilers are connected to the same pipe, and when one is empty and under repair.

5. Blow off cock

The principal functions of a blow-off cock are :

3. To empty the boiler whenever required.
4. To discharge the mud, scale or sediments which are accumulated at the bottom of the boiler.

The blow-off cock, as shown in Fig. 3.10, is fitted to the bottom of a boiler drum and consists of a conical plug fitted to the body or casing. The casing is packed, with asbestos packing, in grooves round the top and bottom of the plug. The asbestos packing is made tight and plug bears on the packing. It may be noted that the cocks packed in this way keep the grip better under high pressure and easily operated than unpacked.

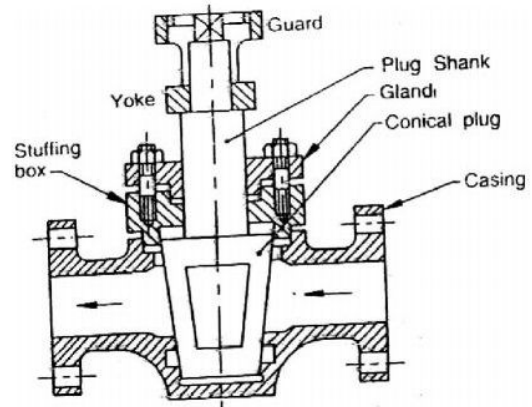

Fig. 3.10 Blow off cock

The shank of plug passes through a gland and stuffing box in the cover. The plug is held down by a yoke and two stud bolts (not shown in the figure). The yoke forms a guard on it. There are two vertical slots on the inside of a guard for the box spanner to be used for operating the cock.

6. Feed check valve

It is a non-return valve, fitted to a screwed spindle to regulate the lift. Its function is to regulate the supply of water, which is pumped into the boiler, by the feed pump. This valve must have its spindle lifted before the pump is started. It is fitted to the shell slightly below the normal water level of the boiler.

A feed check valve for marine boilers is shown in Fig. 3.11. It consists of a valve whose lift is controlled by a spindle and hand wheel. The body of the valve is made of brass casting and except spindle, its every part is made of brass. The spindle is made of muntz metal. A flange is bolted to the end of boiler at a point from which perforated pipe leads the feed water. This pipe distributes the water in the boiler uniformly.

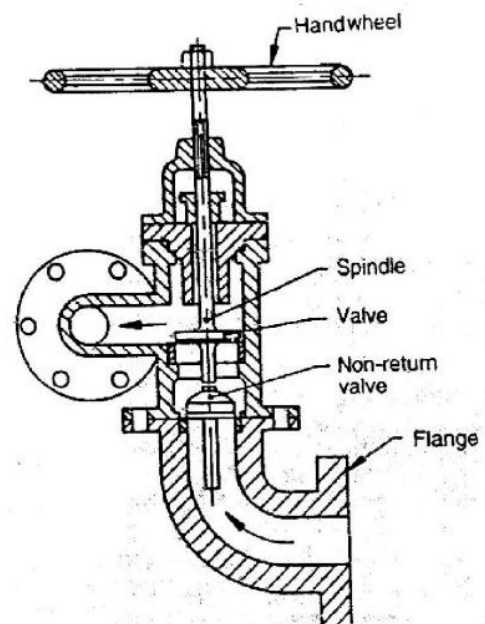

Fig. 3.11 Feed check valve and

7. Fusible plug

It is fitted to the crown plate of the furnace or the fire box. Its object is to put off the fire in the furnace of the boiler when the level of water in the boiler falls to an unsafe limit, and thus avoids the explosion which may take place due to overheating of the furnace plate.

A fusible plug consists of a hollow gun metal plug P, as shown in Fig. 3.12. It is screwed to the furnace crown. A second hollow gun metal plug P2 is screwed to the first plug. There is also a third hollow gun metal plug P3 separated from P, by a ring of fusible metal. The inner surface of P2 and outer surface of P3 are grooved so that when the fusible metal is poured into the plug, P2 and P3 are locked together. A hexagonal flange is provided on plug P, to take a spanner for fixing or removing the plug. There is a hexagonal flange on plug P2 for fixing or removing it. The fusible metal is protected from fire by the flange on the lower end of plug P2. There is also a contact at the top between P2 and P3 so that the fusible metal is completely enclosed.

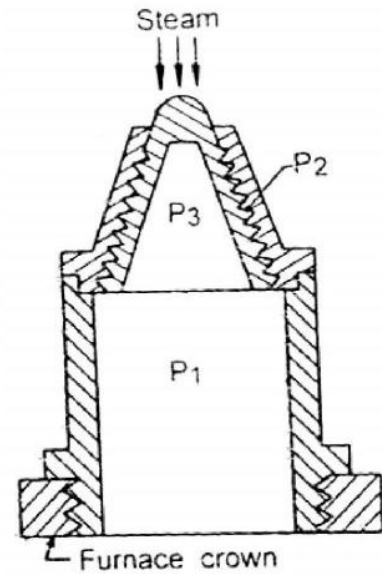

Fig. 3.12 Fusible plug

The fusible plugs must be kept in a good condition and replaced annually. A fusible plug must not be refilled with anything except fusible metal.

3.3.2 Boiler Accessories

These are the devices which are used as integral parts of a boiler, and help in running efficiently. Though there are many types of boiler accessories, yet the following are important from the subject point of view :

1. Feed pump
2. Superheater
3. Economiser and
4. Air Preheater

Fig. 3.13. shows the schematic diagram of a boiler plant with the above mentioned accessories.

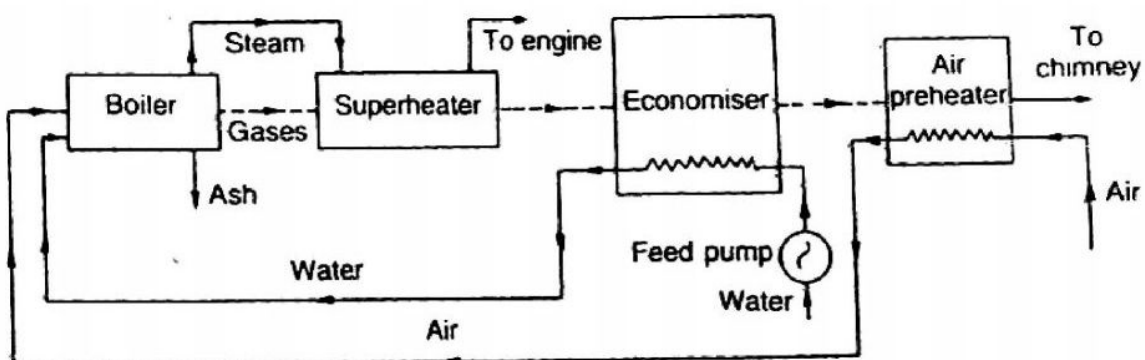

Fig. 3.13 schematic diagram of a boiler plant

1. Feed Pump

We know that water, in a boiler, is continuously converted into steam, which is used by the engine. Thus we need a feed pump to deliver water to the boiler.

The pressure of steam inside a boiler is high. So the pressure of feed water has to be increased proportionately before it is made to enter the boiler. Generally, the pressure of feed water is 20% more than that in the boiler.

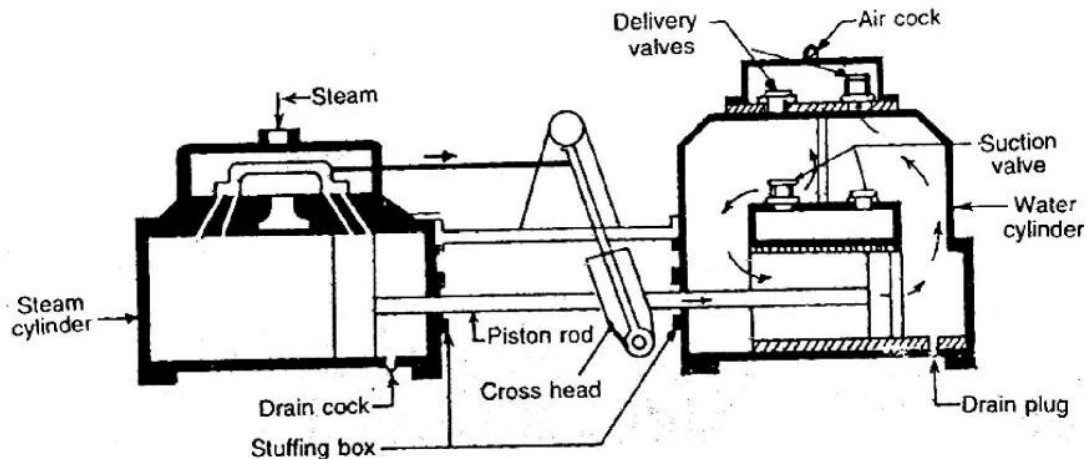

Fig. 3.14 Duplex feed Pump

A feed pump may be of centrifugal type or reciprocating type. But a double acting reciprocating pump is commonly used as a feed pump these days. The reciprocating pumps are run by the steam from the same boiler in which water is to be fed. These pumps may be classified as simplex, duplex and triplex pumps according to the number of pump cylinders. The common type of pump used is a duplex feed pump, as shown in Fig. 3.14. This pump has two sets of suction and delivery valves for forward and backward stroke. The two pumps work alternately so as to ensure continuous supply of feed water.

2. Superheater

A superheater is an important device of a steam generating unit. Its purpose is to increase the temperature of saturated steam without raising its pressure. It is generally an integral part of a boiler, and is placed in the path of hot flue gases from the furnace. The heat, given up by these flue gases, is used in superheating the steam. Such superheaters, which are installed within the boiler, are known as integral superheaters.

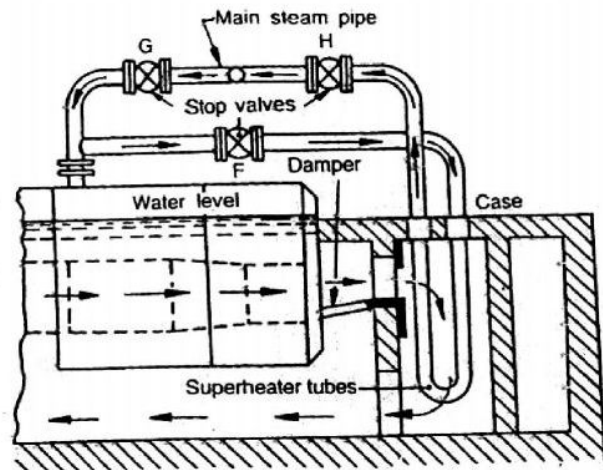

Fig. 3.15 Superheater

A Sudgen's superheater commonly employed with Lancashire boilers is shown in Fig. 3.15. It consists of two mild steel boxes or heaters from which hangs a group of solid drawn tubes bent to U-form. The ends of these tubes are expanded into the headers. The tubes are arranged in groups of four and one pair of headers generally carries ten of these groups or forty tubes in all. The outside of the tubes can be cleaned through the space between the headers. This space is closed by covers.

The steam enters at one end of the rear header and leaves at the opposite end of the front header. The overheating of superheater tubes is prevented by the use of a balanced damper which is operated by the handle. The superheater is in action when the damper is in a position as shown in the figure. If the damper is in vertical position, the gases pass directly into the bottom flue without passing over the superheater tubes. In this way, the superheater is out of action. By placing the damper in intermediate position, some of the gases will pass over the superheater tubes and the remainder will pass directly to the bottom flue. It is thus obvious, that required degree of heat for superheating may be obtained by altering the position of the damper.

It may be noted that when the superheater is in action, the stop valves G and H are opened and F is closed. When the steam is taken directly from the boiler, the valves G and H are closed and F is open.

3. Economiser

An economiser is a device used to heat feed water by utilising the heat in the exhaust flue gases before leaving through the chimney. As the name indicates, the economiser improves the economy of the steam boiler.

A well known type of economiser is Greens economiser. It is extensively used for stationary boilers, especially those of Lancashire type. It consists of a large number of vertical pipes or tubes placed in an enlargement of the flue gases between the boiler and chimney as shown in Fig. 3.16. These tubes are 2.75 meters long, 114 mm in external diameter and 11.5 mm thick and are made of cast iron.

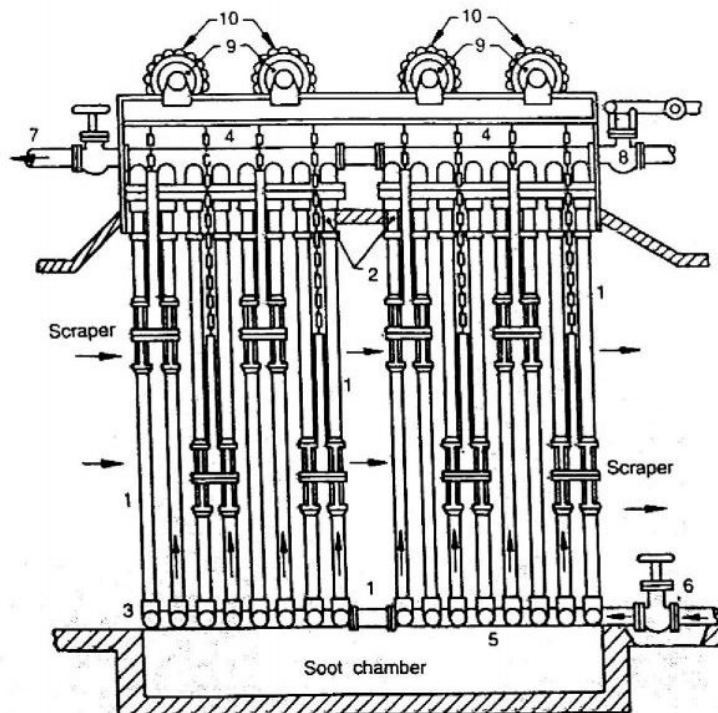

Fig. 3.16 Economiser

The economiser is built-up of transverse section. Each section consists of generally six or eight vertical tubes (1). These tubes are joined to horizontal pipes or boxes (2) and (3) at the top and bottom respectively. The top boxes (2) of the different sections are connected to the pipe (4),

while the bottom boxes are connected to pipe (5). The pipes (4) and (5) are on opposite sides, which are outside the brickwork enclosing the economiser.

The feed water is pumped into the economiser at (6) and enters the pipe (5). It then passes into the bottom boxes (3) and then into the top boxes (2) through the tubes (1). It is now led by the pipe (4) to the pipe (7) and then to the boiler. There is a blow-off cock at the end of the pipe (5) opposite to the feed inlet (6). The purpose of this valve is to remove mud or sediment deposited in the bottom boxes. At the end of pipe (4) (opposite to the feed outlet) there is a safety valve.

It is essential that the vertical tubes may be kept free from deposits of soot, which greatly affect efficiencies of the economiser. Each tube is provided with scraper for this purpose. The scrapers of two adjoining sections of tubes are grouped together, and coupled by rods and chains to the adjacent group of scrapers. The chain passes over a pulley (9) so that one group of scrapers balance the adjacent group. The pulley (9) of each chain is connected to a worm wheel (10) which is driven by a worm on a longitudinal shaft (not shown in the figure). The scrapers automatically reverse when they reach the top or bottom end of the tubes. These are kept in motion continuously when the economiser is in use. The speed of scraper is about 46 m/h.

It may be noted that the temperature of feed should not be less than about 35° C, otherwise there is a danger of corrosion due to the moisture in the flue gases being deposited in cold tubes. Following are the advantages of using an economiser

4. There is about 15 to 20% of coal saving.
5. It increases the steam raising capacity of a boiler because it shortens the time required to convert water into steam.
6. It prevents formation of scale in boiler water tubes, because the scale formed in the economiser tubes, can be cleaned easily.
7. Since the feed water entering the boiler is hot, therefore strains due to unequal expansion are minimised.

4. Air Preheater

An air preheater is used to recover heat from the exhaust flue gases. It is installed between the economiser and the chimney. The air required for the purpose of combustion is drawn through the air preheater where its temperature is raised. It is then passed through ducts to the furnace. The air is passed through the tubes of the heater internally while the hot flue gases are passed over the outside of the tubes.

The following advantages are obtained by using an air preheater:

1. The preheated air gives higher furnace temperature which results in more heat transfer to the water and thus increases the evaporative capacity per kg of fuel.
2. There is an increase of about 2% in the boiler efficiency for each 35-40° C rise in temperature of air.
3. It results in better combustion with less soot, smoke and ash.

It enables a low grade fuel to be burnt with less excess air.

SIMPLE STEAM ENGINES

Introduction

In all steam engines, the steam is used as the working substance. These engines operate on the principle of first law of thermodynamics, i.e. heat and work are mutually convertible. In a reciprocating steam engine, as the heat energy in the steam is converted into mechanical work by the reciprocating (to and fro) motion of the piston, it is also called reciprocating steam engine. Moreover, as the combustion of the fuel takes place outside the engine cylinder, it is also called an external combustion engine.

1. Important Parts of a Steam Engine

All the parts of a steam engine may be broadly divided into two groups i.e. stationary parts and moving parts. Though a steam engine consists of innumerable parts, both stationary and moving, yet the following are important from the subject point of view :

1. **Frame**- It is a heavy cast iron part, which supports all the stationary as well as moving parts and holds them in proper position. It generally, rests on engine foundations.

2. **Cylinder**- It is also a cast iron cylindrical hollow vessel, in which the piston moves to and fro under the steam pressure. Both ends of the cylinder are closed and made steam tight. In small steam engines, the cylinder is made an integral part of the frame.

3. **Steam chest**- It is casted as an integral part of the cylinder. It supplies steam to the cylinder with the movement of D-slide valve.

4. **D-slide valve**- It moves in the steam chest with simple harmonic motion. Its function is to exhaust steam from the cylinder at proper movement.

5. **Inlet and exhaust ports**- These are holes provided in the body of the cylinder for the movement of steam. The steam is admitted from the steam chest alternately to either sides of the cylinder through the inlet ports. The steam, after doing its work in the cylinder, is exhausted through the exhaust port.

6. **Piston** - It is a cylindrical disc, moving to and fro, in the cylinder because of the steam pressure. Its function is to convert heat energy of the steam into mechanical work. Piston rings, made from cast iron, are fitted in the grooves in the piston. Their purpose is to prevent the leakage of steam.

7. **Piston rod** - It is a circular rod, which is connected to the piston on one side and cross head to the other. Its main function is to transfer motion from the piston to the cross-head.

8. **Cross head** - It is a link between the piston rod and connecting rod. Its function is to guide motion of the piston rod and to prevent it from bending.

9. **Connecting rod**- It is made of forged steel, whose one end is connected to the cross head and the other to the crank. Its function is to convert reciprocating motion of the piston (or cross head) into rotary motion of the crank.

10. **Crank shaft**- It is the main shaft of the engine having a crank. The crank works on the lever principle and produces rotary motion of the shaft. The crank shaft is supported on main bearing of the engine.

11. **Eccentric** - It is generally made of cast iron, and is fitted to the crank shaft. Its function is to provide reciprocating motion to the slide valve.

12. **Eccentric rod and valve rod**- The eccentric rod is made of forged steel, whose one end is fixed to the eccentric and other to the valve rod. Its function is to convert rotary motion of the crankshaft into to and fro motion of the valve rod. The valve rod connects the eccentric and the D-slide valve. Its function is to provide simple harmonic motion to the D-slide valve.

13. **Flywheel**- It is a heavy cast iron wheel, mounted on the crank shaft. Its function is to prevent the fluctuation of engine. It also prevents the jerks to the crankshaft.

14. **Governor**- It is a device to keep the engine speed, more or less, uniform at all load conditions. It is done either by controlling the quantity or pressure of the steam supplied to the engine.

4.1. Working of a Single Cylinder Double Acting Horizontal Reciprocating Steam Engine

The principal parts of a single cylinder, double acting horizontal reciprocating steam engine are shown in Fig. 4.1.

The superheated steam at a high pressure (about 20 atmospheres) from the boiler is led into the steam chest. After that the steam makes its way into the cylinder through any of the ports 'a' or 'b' depending upon the position of the D-slide valve. When port 'a' is open, the steam rushes to the left side of the piston and forces it to the right. At this stage, the slide valve covers the exhaust port and the other steam port 'b' as shown in Fig. 4.1. Since the pressure of steam is greater on the left side than that on right side, the piston moves to the right.

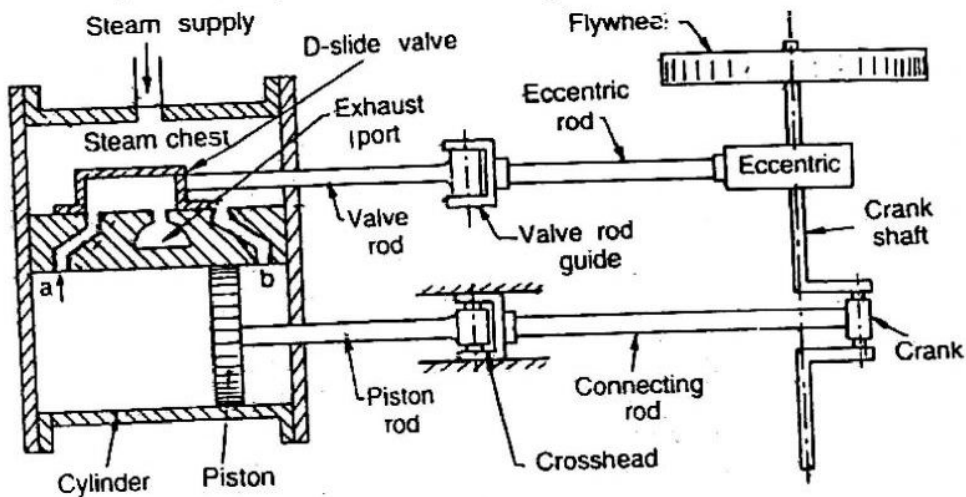

Fig. 4.1 Single cylinder, double acting horizontal reciprocating steam engine

When the piston reaches near the end of the cylinder, it closes the steam port 'a' and exhaust port. The steam port 'b' is now open, and the steam rushes to the right side of the piston. This forces the piston to the left and at the same time the exhaust steam goes out through the exhaust pipe, and thus completes the cycle of operation. The same process is repeated in other cycles of operation, and as such the engine works.

Note : At the end of each stroke, the piston changes its direction of motion and is momentarily stopped. The crank comes in line with the piston rod. The extreme left and right positions of the crank, where the piston rod exerts no turning tendency on the main shaft, are called dead centre's of the crank.

Important Terms used in Steam Engines

The theoretical indicator diagram for a simple steam engine is shown in Fig. 4.1. The following are some important terms used in steam engines.

1. **Bore-** The internal diameter of the cylinder of the engine is known as bore.

2. **Dead centre's-** The extreme positions of the piston inside the cylinder during its motion are known as dead centre's. There are two dead centre's, i.e.

(a) Inner dead centre (I.D.C.), and (b) Outer dead centre (O.D.C.).

In a horizontal engine, the inner most position of the piston (towards the cylinder cover end) is known as inner dead centre, whereas the outer most position of the piston towards the crank end is called outer dead centre, as shown in Fig. 4.2.

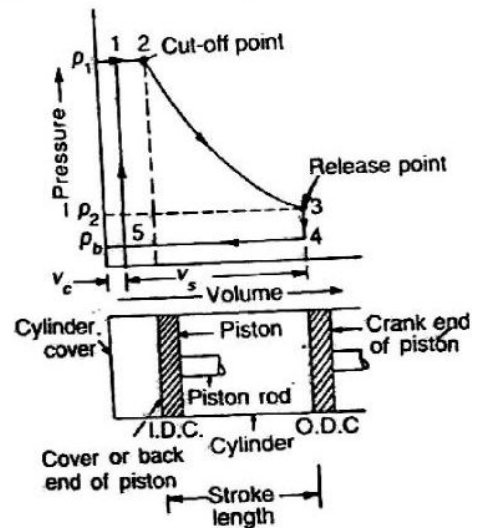

Fig. 4.2 Important Terms used in Steam Engines

3. **Clearance volume-** The volume of space between the cylinder cover and the piston, when the piston is at I.D.C. position is called clearance volume. It is usually represented as a percentage of stroke volume.

4. **Stroke volume or swept volume-** The volume swept by the piston when it moves from I.D.C. to O.D.C., is known as stroke volume or swept volume v_s . It is also known as piston displacement. Mathematically, stroke volume or swept volume,

$$v_s = \frac{\pi}{4} \times D^2 \times L$$

where D = Bore or internal diameter of the cylinder, and

L = Length of the stroke.

5. **Cut-off volume-** Theoretically, the steam from the boiler enters the clearance space and pushes the piston outward doing external work. At some point during outward movement of the piston, the supply of steam is stopped. The point or the volume where the cut-off of steam takes place is called the point of cut-off or cut-off volume.

6. **Average piston speed-** The distance travelled by the piston per unit time is known as average piston speed. Mathematically,

Average piston speed = LN m/min, for single acting steam engine
 = $2LN$ m/min, for double acting steam engine

where L = Length of the stroke in metres, and
 N = Speed in R.P.M.

7. **Mean effective pressure-** The average pressure on the piston during the working stroke is called mean effective pressure. It is given by the mean depth of the p-v diagram. Mathematically, mean effective pressure,

$$P_m = \frac{\text{Work done per cycle}}{\text{Stroke volume}}$$

Indicator Diagram of a Simple Steam Engine

It is a graphical representation of the variation in pressure and volume of steam inside the cylinder or p-v diagram. As a matter of fact, the theoretical or hypothetical indicator diagram of a simple steam engine has been developed from that of a modified Rankine cycle. It is based on the following assumptions :

8. The opening and closing of steam ports is instantaneous.
9. There is no pressure drop due to condensation.
10. There is no wire drawing due to restricted valve opening.
11. The steam is admitted at boiler pressure and exhausted at condenser pressure.
12. The expansion (or compression) of the steam is hyperbolic (i.e. $pv = C$)

It may be noted that the above assumptions are not correct from the practical point of view. As a result of this, it has lead to the change in the indicator diagram from the basic modified Rankine cycle.

Note : In the succeeding articles, we shall discuss work done and mean effective pressure (also known as theoretical work done and theoretical mean effective pressure) from the theoretical indicator diagrams.

4.2. Theoretical or Hypothetical Indicator Diagram

The theoretical or hypothetical indicator diagram without clearance and with clearance is shown in Fig. 4.3. In other words, if there is no steam in the cylinder (or there is zero volume of

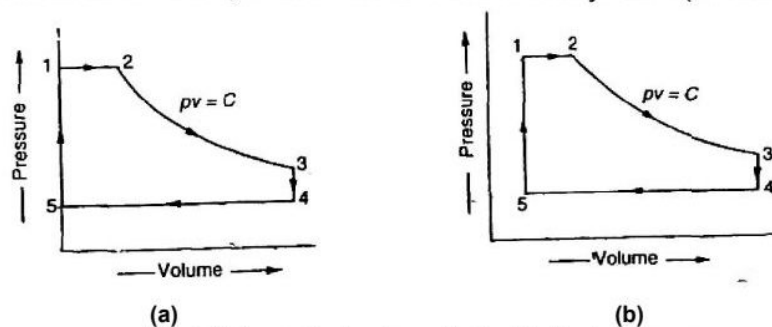

Fig. 4.3 Theoretical or hypothetical indicator diagram

steam at point 1), the indicator diagram will be as shown in Fig. 4.3 (a). Similarly, if there is some steam in the cylinder at point 1, the indicator diagram will be as shown in Fig. 4.3 (b).

The sequence of processes is given below :

1. **Process 1-2** - At point 1, the steam is admitted into the cylinder through the inlet port. As the piston moves towards right, therefore the steam is admitted at constant pressure. Since the supply of steam is cut off at point 2, therefore this point is known as cut-off point.

2. **Process 2-3**- At point 2, expansion of steam, in the cylinder, starts with movement of the piston till it reaches the dead end. This expansion takes place hyperbolically (i.e. $pv=C$) and pressure falls considerably as-shown in Fig. 4.4.

3. **Process 3-4**- At point 3, the exhaust port opens and steam is released from the cylinder to the exhaust. As a result of steam exhaust, pressure in the cylinder falls suddenly (without change in volume) as shown in Fig. 4.4. The point 3 is known as release point.

4. **Process 4-5**- At point 4, return journey of the piston starts. Now the used steam is exhausted at constant pressure, till the exhaust port is closed, and the inlet port is open. The steam pressure at point 4 is called back pressure.

5. **Process 5-1**- At point 5, the inlet port is opened and some steam suddenly enters into the cylinder, which increases the pressure of steam (without change in volume). This process continues till the original position is restored.

Theoretical or Hypothetical Mean Effective Pressure

The theoretical or hypothetical mean effective pressure may be determined as discussed below, by considering the theoretical indicator diagram without clearance and with clearance as shown in Fig. 4.4 (a) and (b) respectively.

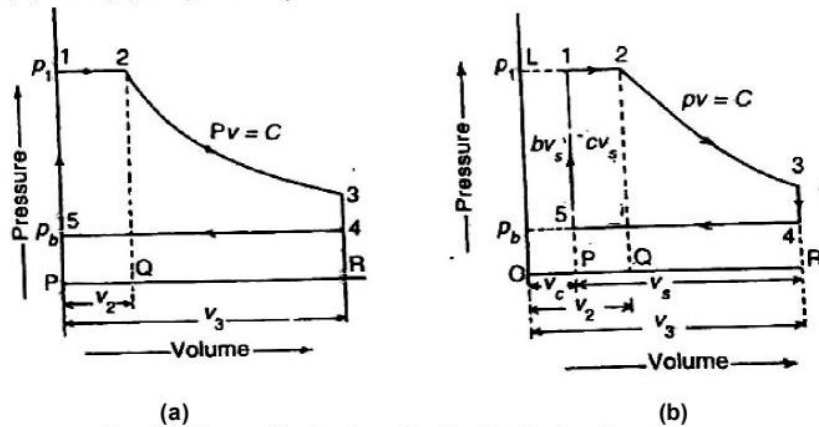

Fig. 4.4. Theoretical or hypothetical indicator diagram.

1. Considering the theoretical or hypothetical indicator diagram without clearance

The theoretical or hypothetical indicator diagram without clearance is shown in Fig. 4.4 (a).

Let P_1 = Initial or admission pressure of steam (i.e. pressure at point 1) or boiler pressure,

P_b = Back pressure {i.e. pressure at point 4 or 5} or condenser pressure,

v_2 = Volume of steam in the cylinder at the point of cut-off {i.e. volume at point 2}, and

v_3 = Stroke volume or swept volume or piston displacement volume. It is the volume of steam in the cylinder at the end of stroke (i.e. volume at point 3 or 4).

We know that theoretical or hypothetical work done per cycle

$$\begin{aligned} &= \text{Area of figure 123451} \\ &= \text{Area 12 QP} + \text{Area 23 RQ} - \text{Area 45PR} \\ &= P_1 v_2 + 2.3 P_1 v_2 \log(v_3 / v_2) - P_b v_3 \end{aligned}$$

and theoretical or hypothetical mean effective pressure,

$$\begin{aligned} P_m &= \frac{\text{Work done per cycle}}{\text{Stroke volume}} = \frac{P_1 v_2 + 2.3 P_1 v_2 \log(v_3 / v_2) - P_b v_3}{v_3} \\ &= P_1 \times \frac{v_2}{v_3} + 2.3 P_1 \frac{v_2}{v_3} \log(V_3 / V_2) - P_b = \frac{P_1}{r} (1 + 2.3 \log r) - P_b \\ &= r = V_3 / V_2 = \text{Expansion ratio} \\ &= \frac{\text{Volume of steam in the cylinder at the end of stroke}}{\text{Volume of steam at the point of cut - off}} \end{aligned}$$

- Notes :
1. The Volume of steam in the cylinder at the end of stroke, neglecting clearance, is equal to stroke volume.
 2. The ratio v_2/v_3 (i.e. reciprocal of expansion ratio) is termed as cut-off ratio. It is defined as the ratio of volume between the points of admission and cut-off of steam and the stroke volume.
 3. The steam consumption in kg per cycle may be obtained as follows:

$$\begin{aligned} &\text{Steam consumption per cycle} \\ &= \frac{\text{Volume of steam supplied per cycle in m}^3}{\text{Specific volume of dry steam at admission pressure (P}_1\text{) in m}^3 / \text{kg, from steam tables}} \\ &= \frac{\text{Volume of steam in the cylinder at the point of cut - off (v}_2\text{)}}{v_g} \end{aligned}$$

If the steam is initially wet having dryness fraction x , then steam consumption per cycle

$$= \frac{v_2}{x v_g} \text{ kg, } x = \text{dryness fraction}$$

Example-1

A steam engine cylinder receives steam at a pressure of 11.5 bar and cut-off takes place at half of the stroke. Find the theoretical mean effective pressure, if the back pressure of the steam is 0.15 bar. Neglect clearance.

Solution Given

$$P_1 = 11.5 \text{ bar; } v_2 = 0.5 v_3; P_b = 0.15 \text{ bar}$$

We know that theoretical mean effective pressure,

$$r = v_3 / v_2 = v_3 / 0.5 v_3 = 2$$

We know that theoretical mean effective pressure,

$$\begin{aligned} P_m &= \frac{P_1}{r} (1 + 2.3 \log r) - P_b \\ &= \frac{11}{5} (1 + 2.3 \log 2) - 0.15 = 9.58 \text{ bar Ans.} \end{aligned}$$

Example-2

The steam is supplied at a pressure of 8.4 bar and cut-off occurs at 0.35 of the stroke. The back pressure is 1.25 bar. If the diagram factor is 0.75, determine the actual mean effective pressure. Neglect clearance.

Solution

Given Data

$$P_1 = 8.4 \text{ bar}; v_2 = 0.35 v_3; P_b = 1.25 \text{ bar}; K = 0.75$$

We know that expansion ratio,

$$r = v_3 / v_2 = v_3 / 0.35 v_3 = 2.86$$

We know that theoretical mean effective pressure,

$$\begin{aligned} P_m &= \frac{P_1}{r} (1 + 2.3 \log r) - P_b \\ &= \frac{8.4}{2.86} (1 + 2.3 \log 2.86) - 1.25 = 4.77 \text{ bar} \end{aligned}$$

∴ Actual mean effective pressure,

$$P_a = P_m \times K = 4.77 \times 0.75 = 3.58 \text{ bar (Ans.)}$$

Power developed by a Simple Steam Engine.

The term 'power' may be defined as the rate of doing work. It is thus the measure of performance of a steam engine, e.g. an engine doing a certain amount of work in one second will be twice as powerful as an engine doing the same amount of work in two seconds. Mathematically power developed by an engine.

$$P = \frac{\text{Work done}}{\text{Time taken}}$$

In S.I system of units, the unit of power is watt (briefly written as W) which is equal to 1 N-m/s or 1 J/s. Generally, a bigger unit of power known as kilowatt (briefly written as kW) is used which is equal to 1000W.

In case of steam engines, the following two terms are commonly used for the power developed.

1. Indicated power, and
2. Brake power

4.3. Indicated power

Actual power generated in the engine cylinder is called power input or indicated power (briefly written as I.P). Since the instrument used to draw the p-v diagram (from which work done during the stroke is obtained), is known as indicator, that is why this power is called indicated power. Now consider a simple steam engine, whose indicated power is required to be found out.

Let P_a = Actual mean effective pressure in N/m^2

A = Area of the cylinder or piston in m^2

L = Length of the stroke in metres, and

N = Speed of the crankshaft in revolution per minute (r.p.m)

We know that force on the piston

$$= \text{Pressure} \times \text{Area} = P_a \times A \text{ (in N)}$$

and work done per stroke = $P_a \times A \times L$ N-m

\therefore Work done per minute

$$= P_a \times A \times L \times N \quad \dots \text{ (For single acting)}$$

$$= P_a \times A \times L \times 2N \quad \dots \text{ (For double acting)}$$

and indicated power,

$$I.P. = \frac{P_a LAN}{60} \text{ W} \quad \dots \text{ (For single acting)}$$

$$[\because 1 \text{ N-m/s or } 1 \text{ J/s} = 1 \text{ W}]$$

$$= \frac{2P_a LAN}{60} \text{ W} \quad \dots \text{ (For double acting)}$$

When the actual mean effective pressure is given in bar, then

$$I.P. = \frac{P_a \times 10^5 \times LAN}{60} \text{ W} \quad \dots \text{ (}\because 1 \text{ bar} = 10^5 \text{ N/m}^2\text{)}$$

$$= \frac{P_a \times 10^5 \times LAN}{60 \times 1000} \text{ kW} = \frac{100P_a \times LAN}{60} \text{ kW} \quad \dots \text{ (For single acting)}$$

$$= \frac{200P_a \times LAN}{60} \text{ kW} \quad \dots \text{ (For double acting)}$$

Note : The value of actual mean effective pressure (P_a) may also be obtained from the following expression :

$$P_a = \frac{\text{Area of actual indicator diagram in } M^2 \times \text{Spring strength in bar / m}}{\text{Length of actual indicator diagram in m}} \text{ (in bar).}$$

Example-3

A double acting single cylinder has 200mm stroke, 160mm diameter. It runs at 250 r.p.m and the cut-off is 25% of the stroke. The pressure at cut-off is 15 bar and exhaust is at 0.3 bar for a diagram factor of 0.75. Estimate the indicated power in kW.

Solution

$L = 200\text{mm} = 0.2\text{m}$; $D = 160\text{mm} = 0.16\text{m}$; $N = 250\text{ r.p.m}$; $v_2 = 25\%$ of stroke $= 0.25 v_3$; $P_1 = 15\text{ bar}$; $P_b = 0.3\text{bar}$; $K = 0.75$

We know that expansion ratio,

$$r = v_3 / v_2 = v_3 / 0.25 v_3 = 4$$

∴ Theoretical mean effective pressure,

$$\begin{aligned} P_m &= \frac{P_1}{r} (1 + 2.3 \log r) - P_b \\ &= \frac{15}{4} (1 + 2.3 \log 4) - 0.3 = 8.64 \text{ bar} \end{aligned}$$

and actual mean effective pressure,

$$P_a = P_m \times K = 8.64 \times 0.75 = 6.48 \text{ bar}$$

Area of the cylinder

$$A = \frac{\pi}{4} \times D^2 = \frac{\pi}{4} (0.16)^2 = 0.02\text{m}^2$$

We know that indicated power

$$\begin{aligned} I.P. &= \frac{200 P_a L A N}{60} = \frac{200 \times 6.48 \times 0.2 \times 0.02 \times 250}{60} \text{ kW} \\ &= 21.6 \text{ kW Ans.} \end{aligned}$$

Example-4

Calculate the indicated power and steam consumption in kg/h of a double acting steam engine from the following data :

Diameter of cylinder = 300 mm; stroke = 450 mm; R.P.M = 120; Steam pressure = 7 bar, and 0.9 dry; Back pressure = 1.2 bar; Cut-off takes place at 32% of stroke for both ends.

Solution

Given $D=300 = 0.3\text{m}$; $L = 450\text{mm} = 0.45\text{m}$; $N = 120 \text{ r.p.m}$; $P_1 = 7 \text{ bar}$; $K=0.9$; $P_b = 1.2 \text{ bar}$.

Since the cut-off takes place at 32% of the stroke for both ends, therefore

Volume at cut-off

$$= 0.32 \times \text{Stroke volume}$$

$$= 0.32 \times \frac{\pi}{4} \times D^2 \times L = 0.32 \times \frac{\pi}{4} (0.3)^2 = 0.01\text{m}^3$$

and expansion ratio,

$$= r = \frac{1}{0.32} = 3.125$$

indicated power

We know that actual mean effective pressure,

$$P_a = K \left[\frac{P_1}{r} (1 + 2.3 \log r) - P_b \right]$$
$$= 1 \left[\frac{7}{3.125} (1 + 2.3 \log 3.125) - 1.2 \right] = 3.6 \text{ bar} \quad \dots (\text{Taking } K = 1)$$

Area of cylinder,

$$A = \frac{\pi}{4} \times D^2 = \frac{\pi}{4} (0.3)^2 = 0.07\text{m}^2$$

Indicated power,

$$I.P. = \frac{200 P_a L A N}{60} = \frac{200 \times 3.6 \times 0.45 \times 0.07 \times 120}{60} \text{ kW}$$
$$= 45.4 \text{ kW Ans.}$$

Steam consumption

From steam tables, corresponding to a pressure of 7 bar, we find that specific volume of dry steam.

$$V_R = 0.2727 \text{ m}^3 / \text{kg}$$

We know that mass of steam used per stroke

$$= \frac{\text{Volume of steam at cut - off}}{\text{xvg}} = \frac{0.01}{0.9 \times 0.2727} = 0.0407 \text{ kg}$$

4.3. Calculate MEP, IHP, BHP & Mechanical efficiency.

Introduction

In the last chapter, we have discussed simple steam engines. In this chapter, we have discussed power generated and cylinder dimensions of the steam engines. But in this chapter, we shall discuss their performance i.e. efficiencies, governing etc.

Efficiencies of a Steam Engine

The efficiency of an engine is defined as the ratio of work done to the energy supplied to an engine. The following efficiencies of a steam engine are important from the subject point of view :

1. **Mechanical efficiency**- It is the ratio of the brake power (B.P.) to the indicated power (I.P.). Mathematically, mechanical efficiency,

$$\eta_m = \frac{\text{B.P.}}{\text{I.P.}}$$

It may be observed that the mechanical efficiency is always less than unity (i.e. 100%) because some power is lost in overcoming the engine friction. In other words, the indicated power is always greater than brake power. This power which is lost in overcoming the engine friction is known as frictional power. Therefore, frictional power,

$$\text{F.P.} = \text{I.P.} - \text{B.P.}$$

2. **Overall efficiency**- It is the ratio of the work obtained at the crank shaft in a given time to the energy supplied by fuel during the same time.

Let m_f = Mass of fuel burnt in kg per hour, and

C = Calorific value of fuel in kJ/kg of fuel.

∴ Energy supplied by fuel/min

$$= \frac{m_f \times C}{60} \text{ kJ}$$

and work obtained at the crank shaft/min

$$= \text{B.P.} \times 60 \text{ kJ} \quad \dots \text{ (∵ B.P. is in kW and 1 kW = 1 kJ/s)}$$

$$\eta_0 = \frac{\text{B.P.} \times 60 \times 60}{m_f \times C} = \frac{\text{B.P.} \times 3600}{m_f \times C}$$

3. **Indicated thermal efficiency**- It is the ratio of heat equivalent of indicated power to the energy in the steam supplied per minute.

Let m_s = Mass of steam used in kg/min,
 h_1 = Enthalpy or total heat of steam supplied at admission pressure
 P_1 in kJ/kg (from steam tables), and
 h_{fb} = Enthalpy or sensible heat of feed water at back pressure
 p_b in kJ/kg (from steam tables).

∴ Energy in steam supplied/min

$$= m_s (h_1 - h_{fb}) \text{ kJ/min}$$

and heat equivalent to I.P. = I.P. x 60 kJ/min

∴ Indicated thermal efficiency

$$= \frac{\text{I.P.} \times 60}{m_s (h_1 - h_{fb})}$$

Note: The mass of steam used in kg per indicated power or brake power per hour {i.e. in kg/kWh) is known as specific steam consumption.

We know that mass of steam used per hour = $m_s \times 60$ kg/h

∴ Specific steam consumption

$$= \frac{m_s \times 60}{\text{I.P. or B.P.}} \text{ kg/kWh}$$

4. **Brake thermal efficiency** - It is the ratio of the heat equivalent of brake power to the energy in the steam supplied per minute. Mathematically,

Brake thermal efficiency

$$= \frac{\text{B.P.} \times 60}{m_s (h_1 - h_{fb})}$$

Note : Whenever thermal efficiency is mentioned without qualifying the name, i.e. "indicated" or "brake", the indicated thermal efficiency should be calculated.

5. **Relative efficiency**- The relative efficiency is also known as efficiency ratio. It is the ratio of thermal efficiency to the Rankine efficiency. Mathematically, relative efficiency,

$$\eta = \frac{\text{Thermal efficiency}}{\text{Rankine efficiency}}$$

Example-5

During a test on a single acting non-condensing, single cylinder steam engine, the following observations were recorded:

Bore - 225 mm ; Stroke - 600 mm ; Speed = 100 r.p.m.; Effective brake diameter = 2.75 m ; Net load on the brake = 1650 N ; Area of indicator diagram = 2500 mm² ; Length of indicator diagram = 100 mm ; Spring strength = 530 bar/m.

Determine: 1. Indicated power ; 2. Brake power; and 3. Mechanical efficiency.

Solution

$D = 225 \text{ mm} = 0.225 \text{ m}$; $L = 600 \text{ mm} = 0.6 \text{ m}$; $N = 100 \text{ r.p.m.}$; $D_1 = 2.75 \text{ m}$, $(W - S) = 1650 \text{ N}$; $a_1 = 2500 \text{ mm}^2 = 2500 \times 10^{-6} \text{ m}^2$; $b = 100 \text{ mm} = 0.1 \text{ m}$; $s = 530 \text{ bar/m}$

We know that actual mean effective pressure,

$$P_a = \frac{\text{Area of indicator diagram} \times \text{Spring strength}}{\text{Length of indicator diagram}}$$
$$= \frac{a_1 \times s}{b} = \frac{2500 \times 10^{-6} \times 530}{0.1} = 13.25 \text{ bar}$$

Area of cylinder, $A = \frac{\pi}{4} D^2 = \frac{\pi}{4} (0.225)^2 = 0.04 \text{ m}^2$

1. Indicated power

We know that indicated power,

$$I.P. = \frac{100 P_a L A N}{60} = \frac{100 \times 13.25 \times 0.6 \times 0.04 \times 100}{60}$$

= 53 kW Ans. ... (∵ Engine is single acting)

2. Brake power

We know that brake power,

$$B.P. = \frac{(W - S) \pi D_1 N}{60} = \frac{1650 \times \pi \times 2.75 \times 100}{60} = 23760 \text{ w}$$

= 23.76 kW Ans.

3. Mechanical efficiency

We know that mechanical efficiency,

$$\eta_m = \frac{B.P.}{I.P.} = \frac{23.76}{53} = 0.448 \text{ or } 44.8\% \text{ Ans.}$$

Example - 6

Estimate the brake power of simple steam engine having 250 mm piston diameter, and 40 mm piston rod diameter with 250mm stroke length operating at 300 r.p.m. The initial and back pressure of steam is 8.5 bar and 1.2 bar respectively. Assume 90% mechanical efficiency, cut-off at 25% of the forward stroke and 0.73 diagram factor. Neglect clearance and compression.

Solution given : $D = 250\text{mm} = 0.25\text{ m}$; $d = 40\text{mm} = 0.04\text{m}$; $L = 250\text{mm} = 0.25\text{m}$; $N = 300\text{r.p.m}$; $P_1 = 8.5\text{ bar}$; $P_b = 1.2\text{ bar}$, $\eta_m = 90\% = 0.9$; $v_2 = 0.25 v_3$; $K = 0.73$

We know that expansion ratio,

$$r = \frac{v_3}{v_2} = \frac{v_3}{0.25v_3} = 4$$

and actual mean effective pressure,

$$\begin{aligned} P_a &= K \left[\frac{P_1}{r} (1 + 2.3 \log r) - P_b \right] \\ &= 0.73 \left[\frac{8.5}{4} (1 + 2.3 \log 4) - 1.2 \right] \\ &= 2.82 \text{ bar} \end{aligned}$$

Area of piston,

$$A = \frac{\pi}{4} \times D^2 = \frac{\pi}{4} (0.25)^2 = 0.0491 \text{ m}^2$$

and area of piston rod

$$a = \frac{\pi}{4} \times d^2 = \frac{\pi}{4} (0.04)^2 = 0.00126 \text{ m}^2$$

Indicated power,

$$\begin{aligned} \text{I.P.} &= \frac{100 P_a L A N}{60} + \frac{100 P_a L (A - a) N}{60} = \frac{100 P_a L (2A - a) N}{60} \\ &= \frac{100 \times 2.82 \times 0.25 (2 \times 0.0491 - 0.00126) 300}{60} \text{ kW} \\ &= 34.2 \text{ kW} \end{aligned}$$

We know that mechanical efficiency (η_m)

$$0.9 = \frac{\text{B.P.}}{\text{I.P.}} \text{ or } \text{B.P.} = 0.9 \times \text{I.P.} = 0.9 \times 34.2 = 30.78 \text{ kW (Ans.)}$$

STEAM TURBINE

Introduction

A steam turbine is a prime mover in which rotary motion is obtained by the gradual change of momentum of the steam. We have already discussed that in reciprocating steam engines, the steam acts on the piston, as a load or weight, i.e., the action of steam is static. The static pressure of steam gives to and fro motion to the piston, and conversion of energy takes place through crank and connecting rod.

In steam turbine, the force exerted on the blades is due to the velocity of steam. This is due to the fact that the curved blades by changing the direction of steam receive a force or impulse. The action of steam in this case is said to be dynamic. Thus, the dynamic pressure of steam rotates the runner buckets or blades directly. The turbine blades are curved in such a way that the steam directed towards them, enters without shock, though there is always some loss of energy by the friction upon the surface of blades. In general, a steam turbine, essentially, consists of the following two parts :

The nozzle in which the heat energy of high pressure steam is converted into kinetic energy so that the steam issues from the nozzle with a very high velocity.

The blades which change the direction of steam issuing from the nozzle, so that a force acts on the blades due to change of momentum and propel them.

Thus, the basic principle of operation of a steam turbine is the generation of high velocity steam jet by the expansion of high pressure steam and then conversion of kinetic energy, so obtained into mechanical work on rotor blades.

5.1 Classification of steam Turbines

The steam turbines may be classified into the following types

1. According to the mode of steam action
 - (i) Impulse turbine, and
 - (ii) Reaction turbine
2. According to the direction of steam flow
 - (i) Axial flow turbine, and
 - (ii) Radial flow turbine.
3. According to the exhaust condition of steam
 - (i) Condensing turbine, and
 - (ii) Non-condensing turbine

4. According to the pressure of steam
 - (i) High pressure turbine,
 - (ii) Medium pressure turbine, and
 - (iii) Low pressure turbine
5. According to the number of stages
 - (i) Single stage turbine, and
 - (ii) Multi stage turbine

5.2. Reaction Turbines

Introduction

In a reaction turbine, the steam enters the wheel under pressure and flows over the blades. The steam while gliding, propels the blades and make them to move. As a matter of fact, the turbine runner is rotated by the reactive forces of steam jets. The backward motion of the blades is similar to the recoil of a gun. It may be noted that an absolute reaction turbine is rarely used in actual practice.

5.2.1. Comparison between Impulse Turbine and Reaction Turbine

Following are the few points of comparison between an impulse turbine and a reaction turbine.

	Impulse turbine	Reaction turbine
1.	The steam flows through the nozzles and impinges on the moving blades.	The steam flows first through guide mechanism and then through the moving blades.
2.	The steam impinges on the buckets with kinetic energy.	The steam glides over the moving vanes with pressure and kinetic energy.
3.	The steam may or may not be admitted over the whole circumference.	The steam must be admitted over the whole circumference.
4.	The steam pressure remains constant during its flow through the moving blades.	The steam pressure is reduced during its flow through the moving blades.
5.	The negative velocity of steam while gliding over the blades remains constant (assuming no friction)	The relative velocity of steam while gliding over the moving blades increase (assuming no friction)
6.	The blades are symmetrical.	The blades are not symmetrical.
7.	The number of stages required are less for the same power developed.	The number of stages required are more for the same power developed.

CHAPTER-6.0

STEAM CONDENSER

6.1 Function of Condenser

A steam condenser is a closed vessel into which the steam is exhausted, and condensed after doing work in an engine cylinder or turbine. A steam condenser has the following two objects.

1. The primary object is to maintain a low pressure (below atmospheric pressure) so as to obtain the maximum possible energy from steam and thus to secure a high efficiency.
2. The second object is to supply pure feed water to the hot well, from where it is pumped back to the boiler.

6.2 Classification of Condensers

The steam condensers may be broadly classified into the following two types, depending upon way in which the steam is condensed.

1. Jet condensers or mixing type condensers, and
2. Surface condensers or non-mixing type condensers.

Jet Condensers

These days, the jet condensers are seldom used because there is some loss of condensate during the process of condensation and high power requirements for the pumps used. Moreover, the condensate can not be used as feed water to the boiler as it is not free from salt. However, jet condensers may be used at places where water of good quality is easily available in sufficient quantity.

Types of Jet Condensers

The jet condensers may be further classified, on the basis of the direction of flow of the condensate and the arrangement of the tubing system, into the following four types :

1. Parallel flow jet condenser
2. Counterflow or low level jet condenser
3. Barometric or high level jet condenser, and
4. Ejector condenser.

These condensers are discussed, in detail, in the following pages.

Parallel Flow Jet Condensers

In parallel flow jet condensers, both the steam and water enter at the top, and the mixture is removed from the bottom. The principle of this condenser is shown in Fig. 6.1. The exhaust steam is condensed when it mixes up with water. The condensate, cooling water and air flow downwards and are removed by two separate pumps known as air pump and condensate pump. Sometimes, a single pump known as wet air pump, is also used to remove both air and condensate. But the

former gives a greater vacuum. The condensate pump delivers the condensate to the hot well, from where surplus water flows to the cooling water tank through an overflow pipe.

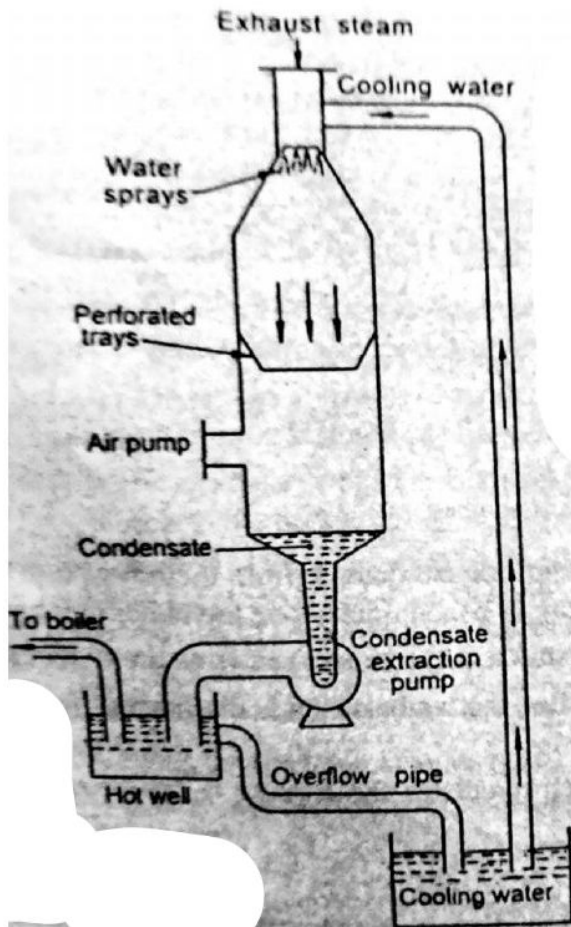

Fig. 6.1 Parallel Flow Jet Condensers

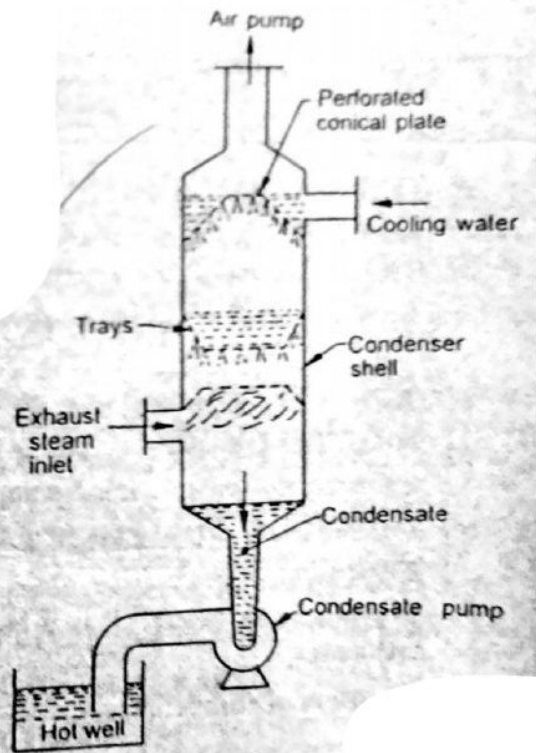

Fig. 6.2 Counterflow or Low level Jet condensers

Counterflow or Low level Jet condensers

In counterflow or low level jet condensers, the exhaust steam enters at the bottom, flows upwards and meets the downcoming cooling water.

The vacuum is created by the air pump, placed at the top of the condenser shell. This draws the supply of cooling water, which falls in a large number of jets, through perforated conical plate as shown in Fig. 6.2. The falling water is caught in the trays, from which it escapes in a second series so that the rapid condensation occurs, and the condensate and cooling water descends through a vertical pipe to the condensate pump, which delivers it to the hot well.

Barometric or High Level Jet Condensers

These condensers are provided at a high level with a long vertical discharge pipe as shown in Fig.6.3. In high level jet condensers, exhaust steam enters at the bottom, flows upwards and meets the downcoming cooling water in the same way as that of low level jet condenser. The

vacuum is created by the air pump, placed at the top of the condenser shell. The condensate and cooling water descends through a vertical pipe to the hot well without the aid of any pump. The surplus water from the hot well flows to the cooling water tank through an overflow pipe.

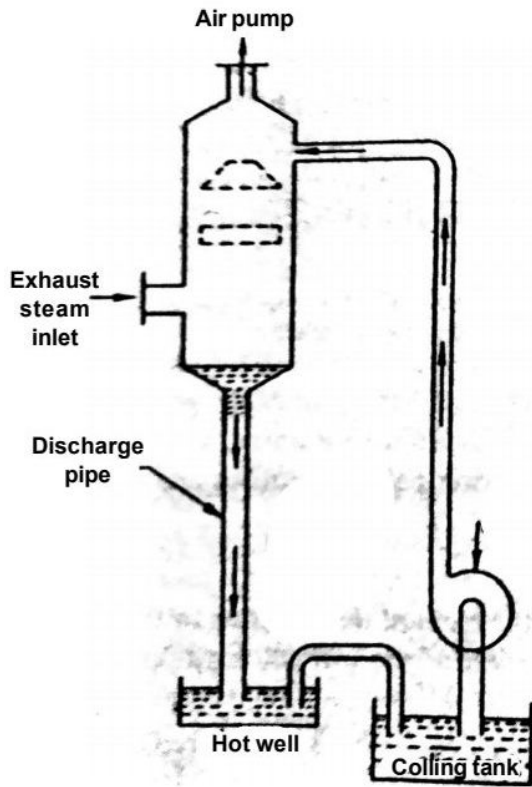

Fig. 6.3 High Level Jet Condensers

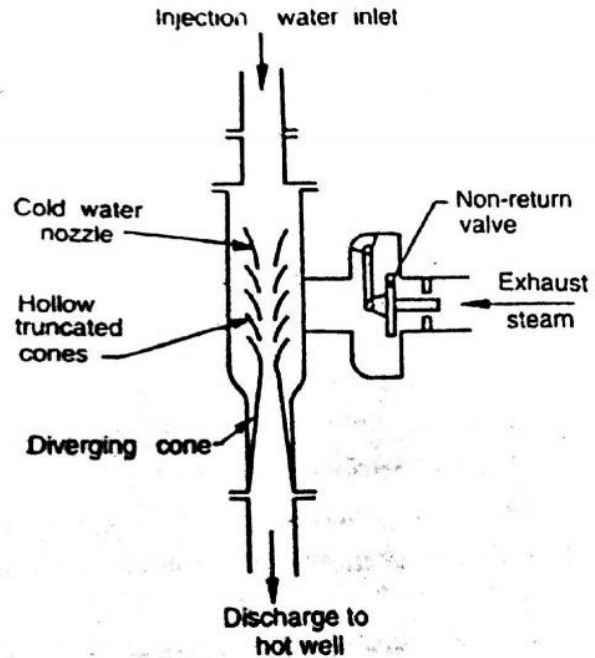

Fig. 6.4 Ejector Condensers

Ejector Condensers

In ejector condensers, the steam and water mix up while passing through a series of metal cones. Water enters at the top through a number of guide cones. The exhaust steam enters the condenser through non-return valve arrangement. The steam and air then passes through the hollow truncated cones. After that it is dragged into the diverging cones where its kinetic energy is partly transformed to pressure energy. The condensate and cooling water is then discharged to the hot well is shown in Fig. 6.4.

Surface Condensers

A surface condenser has a great advantage over the jet condensers, as the condensate does not mix up with the cooling water. As a result of this, whole condensate can be reused in the boiler. This type of condenser is essential in ships which can carry only a limited quantity of fresh water for the boilers. It is also widely used in land installations, where inferior water is available or the better quality of water for feed is to be used economically.

Fig. 6.5 shows a longitudinal section of a two pass surface condenser. It consists of a Horizontal cast iron cylindrical vessel packed with tubes, through which the cooling water flows. The ends of the condenser are cut off by vertical perforated type plates into which water tubes are

fixed. This is done in such a manner that the leakage of water into the centre condensing space is prevented.

The water tubes pass horizontally through the main condensing space for the steam. The steam enters at the top and is forced to flow downwards over the tubes due to the suction of the extraction pump at the bottom.

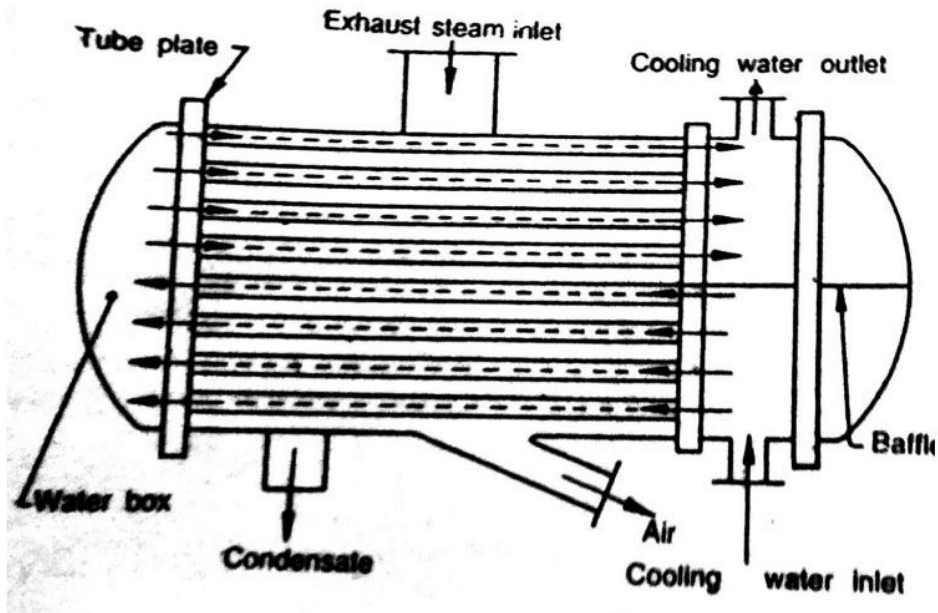

Fig. 6.5 Surface Condensers

The cooling water flows in one direction through the lower half of the tubes and returns in opposite direction through the upper half, as shown in Fig. 6.5.

Types of Surface Condensers

The surface condensers may be further classified on the basis of the direction of flow of the condensate, the arrangement of tubing system and the position of the extraction pump, into the following four types :

1. Down flow surface condenser
2. Central flow surface condenser
3. Regenerative surface condenser and
4. Evaporative condenser.

These condensers are discussed, in detail, in the following pages.

Down Flow Surface Condensers

In down flow surface condensers, the exhaust steam enters at the top and flow downwards over the tubes due to force of gravity as well as suction of the extraction pump fitted at the bottom. The condensate is collected at the bottom and then pumped by the extraction pump. The dry air

pump suction pipe, which is provided near the bottom, is covered by a baffle so as to prevent the entry of condensed steam into it, as shown in Fig. 6.6.

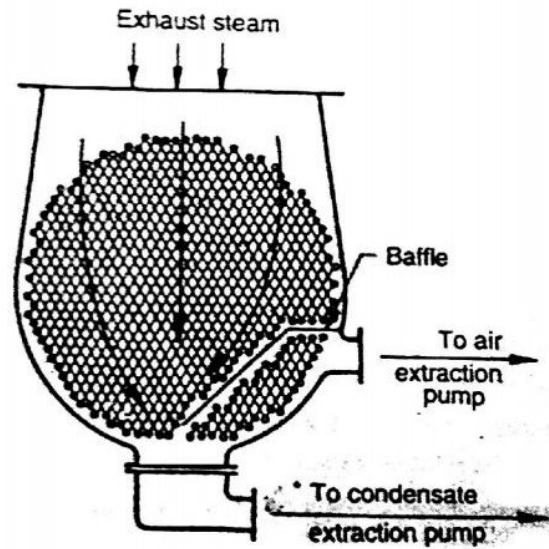

Fig. 6.6 Down Flow Surface Condensers

As the steam flows perpendicular to the direction of flow of cooling water (inside the tubes), this is also called a cross surface condenser.

Central flow surface condensers

In central flow surface condensers, the exhaust steam enters at the top and flow downwards. The suction pipe of the air extraction pump is placed in the centre of the tube nest as shown in Fig. 6.7. This causes the steam to flow radially inwards over the tubes towards the suction pipe. The condensate is collected at the bottom and then pumped by the extraction pump as shown in, Fig. 6.7.

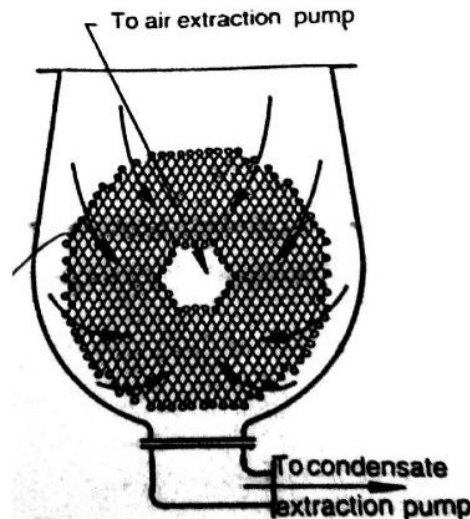

Fig. 6.7 Central flow surface condensers

The central flow surface condenser is an improvement over the down flow type as the steam is directed radially inwards by a volute casing around the tube nest. It, thus, gives an access to the whole periphery of the tubes.

Regenerative Surface Condensers

In regenerative surface condensers, the condensate is heated by a regenerative method. The condensate after leaving the tubes is passed through the exhaust steam from the engine or turbine. It thus, raises its temperature for use as feed water for the boiler.

Evaporative Condenser

The steam to be condensed enters at the top of a series of pipes outside of which a film of cold water is falling. At the same time, a current of air circulates over the water film, causing rapid evaporation of some of the cooling water. As a result of this, the steam circulating inside the pipe is condensate. The remaining cooling water is collected at an increased temperature and is reused. Its original temperature is restored by the addition of the requisite quantity of cold water.

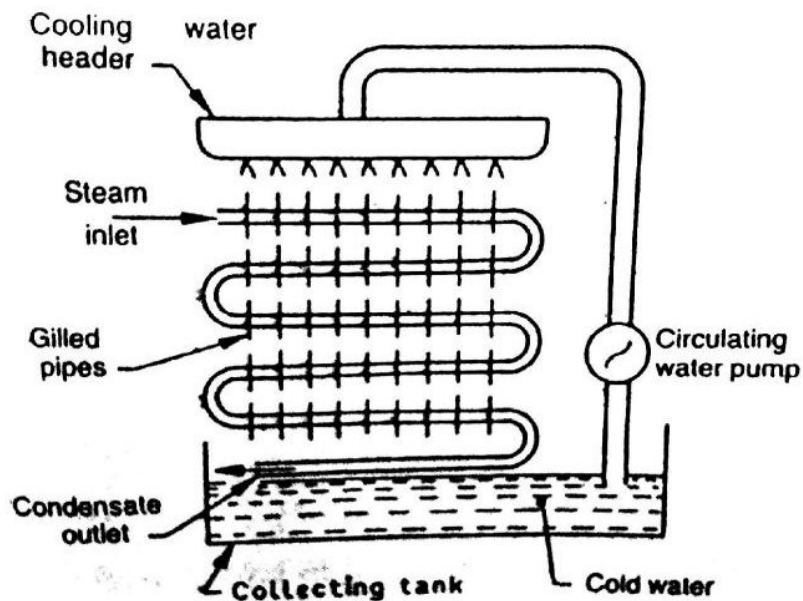

Fig. 6.8 Evaporative Condenser

The evaporative condensers are provided when the circulating water is to be used again and again. These condensers consist of sheets of gilled piping, which is bent backwards and forwards and placed in a vertical plane, as shown in Fig. 6.8.

INTERNAL COMBUSTION ENGINE

Introduction

As the name implies or suggests, the internal combustion engines (briefly written as I.C engine) are those engines in which the combustion of fuel takes place inside the engine cylinder. These are petrol, diesel, and gas engines. We have seen in steam engines or steam turbines that the fuel, fed into the cylinder, is in the form of steam which is already heated (or superheated), and is ready for working in the combustion cycle of the engine. But, in case of internal combustion engines the combustion of fuel takes place inside the engine cylinder by a spark and produces very high temperature.

7.1. Four stroke Cycle Petrol Engine

It is also known as Otto cycle. It requires four strokes of the piston to complete one cycle of operation in the engine cylinder. The four stroke of a petrol engine sucking fuel air mixture (petrol and Air operation with proportionate quantity of air in the carburetor known as charge) are described below :

1. Suction or charging stroke

In this stroke, the inlet valve opens and charge is sucked into the Cylinder as the piston moves downward from top dead centre (T.D.C). It continues till the piston reaches Its bottom dead centre (B.D.C) as show in Fig. 7.1 (a).

2. Compression stroke

In this stroke, both the inlet and exhaust valves are closed and charge is compressed as the piston moves upwards from B.D.C. to T.D.C. As a result of compression the pressure and temperature of the charge increases considerably (the actual values depend upon compression ratio). This completes one revolution of the crankshaft. The compression stroke is showing in Fig. 7.1 (b).

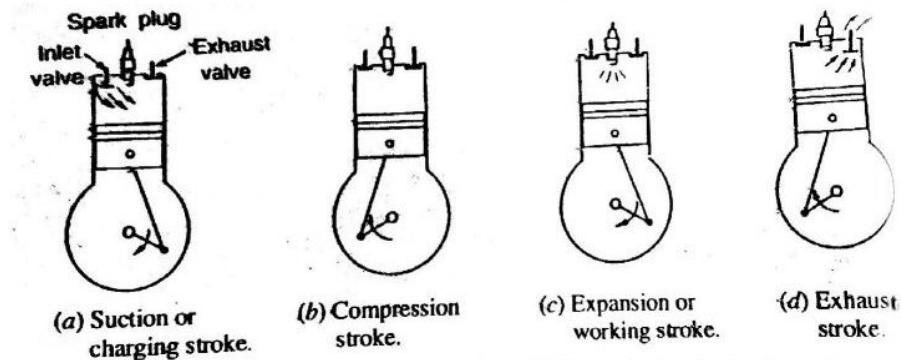

Fig. 7.1 Four stroke Cycle Petrol Engine

3. Expansion or working stroke

Shortly before the piston reaches T.D.C. (during compression stroke), the charge is ignited with the help of a spark plug. It suddenly increases the pressure temperature of the products of combustion but the volume, practically, remains constant. Due to rise in pressure, the piston is pushed down with a great force. The hot burnt gases expand due high speed of the piston. During this expansion, some of the heat energy produced is transformed mechanical work. It may be noted that during this working stroke, as shown in Fig. 7.1 (c), both valves are closed and piston moves from T.D.C. to B.D.C.

6. Exhaust stroke

In this stroke, the exhaust valve is open as piston moves from B.D.C to T.D. C. This movement of the piston pushes out the products of combustion, from the engine cylinder and are exhausted through the exhaust valve into the atmosphere, as shown in Fig. 7.1 (d). This completes the cycle, and the engine cylinder is ready to suck the charge again.

Note : The four stroke cycle petrol engine are usually employed in light vehicles such as cars, jeeps, aero planes

7.1.1. Four stroke Cycle Diesel Engine

It is also known as compression ignition engine because the ignition takes place due to the compression produced in the engine cylinder at the end of compression stroke. The four strokes of a diesel engine sucking pure air are described below :

1. Suction or charging stroke

In this stroke, the inlet valve opens and pure air is sucked into the cylinder as the piston moves downwards from the top dead centre (TDC). It continues till the piston reaches its bottom dead centre (BDC) as shown in Fig. 7.2 (a).

2. Compression stroke

In this stroke, both the valves are closed and the air is compressed as the piston moves upwards from BDC to TDC. As a result of compression, pressure and temperature of the air increases considerably (the actual value depends upon the compression ratio). This completes one revolution of the crank shaft. The compression stroke is shown in Fig. 7.2 (b).

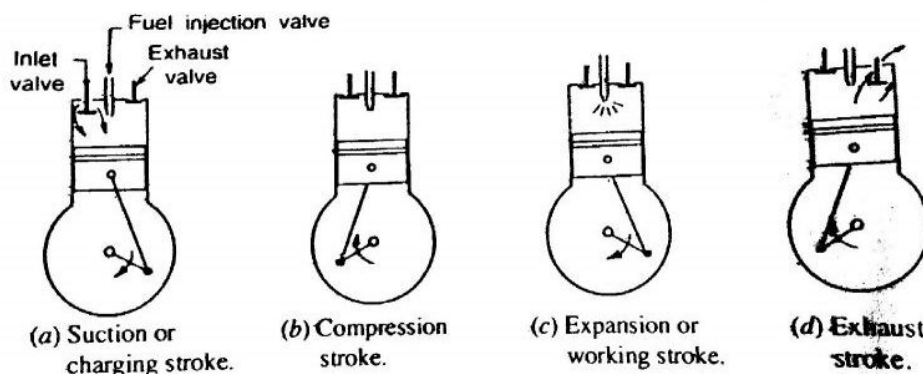

Fig. 7.2 Four stroke Cycle Diesel Engine

3. Expansion or working stroke

Shortly before the piston reaches the TDC (during the compression stroke), fuel oil is injected in the form of very fine spray into the engine cylinder, through the nozzle, known as fuel injection valve. At this moment, temperature of the compressed air sufficiently high to ignite the fuel. It suddenly increases the pressure and temperature of the producer of combustion. The fuel oil is continuously injected for a fraction of the revolution. The fuel oil assumed to be burnt at constant pressure. Due to increased pressure, the piston is pushed down with a great force. The hot burnt gases expand due to high speed of the piston. During this expansion, some of the heat energy is transformed into mechanical work. It may be noted that during this working stroke, both the valves are closed and the piston moves from TDC to BDC.

5. Exhaust stroke

In this stroke, the exhaust valve is open as the piston moves from BDC to TDC. This movement of the piston pushes out the products of combustion from the engine cylinder through the exhaust valve into the atmosphere. This completes the cycle and the engine cylinder ready to suck the fresh air again.

Note : The four stroke cycle diesel engines are generally employed in heavy vehicles such as buses, trucks, tractors, pumping sets, diesel locomotives and in earth moving machinery.

7.1.2. Two-stroke Cycle Petrol Engine

A two-stroke cycle petrol engine was devised by Duglad Clerk in 1880. In this cycle, the suction, compression, expansion and exhaust takes place during two strokes of the piston. It means that there is one working stroke after every revolution of the crank shaft. A two stroke engine has ports instead of valves. All the four stages of a two stroke petrol engine are described below :

1. Suction stage

In this stage, the piston, while going down towards BDC, uncovers both the transfer port and the exhaust port. The fresh fuel-air mixture flows into the engine cylinder from the crank case, as shown in Fig. 7.3 (a).

2. Compression stage

In this stage, the piston, while moving up, first covers the transfer port and then exhaust port. After that the fuel is compressed as the piston moves upwards as shown in Fig.7.3 (b) in this stage, the inlet port opens and fresh fuel-air mixture enters into the crank case.

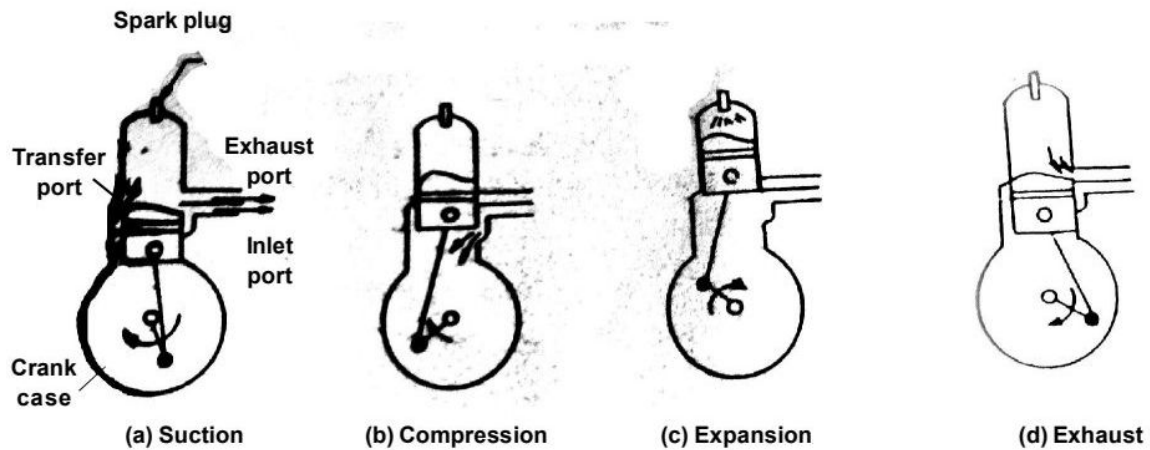

Fig. 7.3 Two-stroke Cycle Petrol Engine

3. Expansion stage

Shortly before this piston reaches the TDC (during compression stroke, the charge is ignited with the help of a spark plug. It suddenly increases the pressure and temperature of the products of combustion. But the volume, practically, remains constant. Due to rise of the pressure the piston is pushed downwards with a great force as shown in Fig. 7.3 (c). The burnt gases expand due to high speed of the piston. During this expansion, some of the heat energy produced is transformed into mechanical work.

4. Exhaust stage

In this stage, the exhaust port is opened as the piston moves downwards, products of combustion, from the engine cylinder are exhausted through the exhaust port into atmosphere as shown in Fig. 7.3 (d). This completes the cycle and the engine cylinder is ready for the charge again.

Note : Two stroke petrol engines are generally employed in very light vehicles such as scooters, motor cycles, and sprayers.

7.1.3. Two-stroke Cycle Diesel Engine

A two-stroke cycle diesel engine also has one working stroke after every revolution of the crank shaft. All the four stages of a two stroke cycle diesel engine are described below :

1. Suction stage

In this stage, the piston while going down towards BDC uncovers the transfer port and the exhaust port. The fresh air flows into the engine cylinder from the crank case as shown in Fig. 7.4 (a).

2. Compression stage

In this stage, the piston while moving up, first covers the transfer port and then exhaust port. After that the air is compressed as the piston moves upwards as shown Fig. 7.4 (b). In this stage, the inlet port opens and the fresh air enters into crank case.

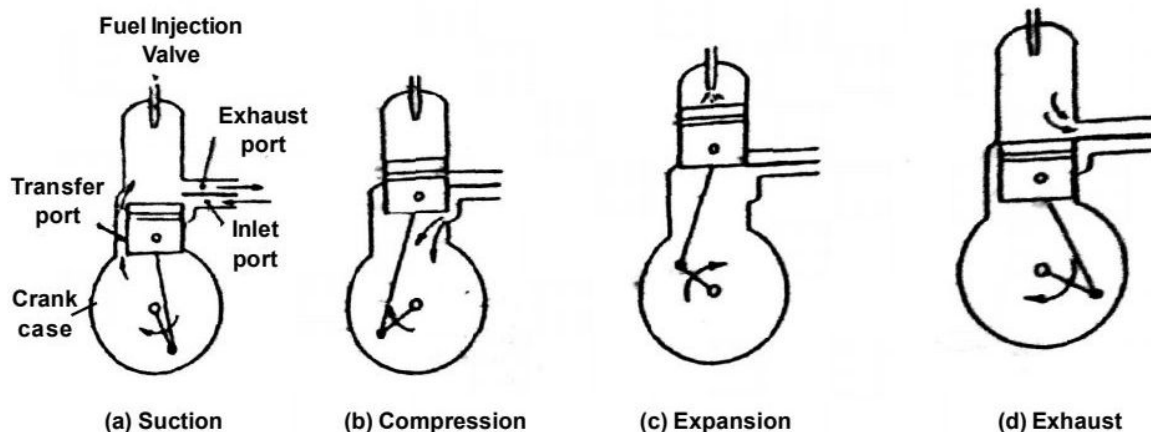

Fig. 7.4 Two-stroke Cycle Diesel Engine

3. Expansion stage

Shortly before the piston reaches the TDC (during compression stroke) the fuel oil is injected in the form of very fine spray into the engine cylinder through the nozzle shown as fuel injection valve, as shown in fig. 7.4 (c). At this moment, temperature of the compressed air is sufficiently high to ignite the fuel. It suddenly increases the pressure and temperature of the products of combustion. The fuel oil is continuously injected for a fraction of the crank rotation. The fuel oil is assumed to be burnt at constant pressure. Due to increased pressure, the piston is pushed with a great force. The hot burnt gases expand due to high speed of the piston. During expansion some of the heat energy produced is transformed into mechanical work.

4. Exhaust stage

In this stage, the exhaust port is opened and the piston moves downwards. The products of combustion from the engine cylinder are exhausted through the exhaust port into the atmosphere as shown in Fig. 7.4 (d). This completes the cycle, and the engine cylinder is ready to suck the air again.

Notes : Two stroke diesel engines are mainly used in marine propulsion where space and lightness are the main considerations.

7.2. Difference between two stroke and four stroke cycle engine.

In a two-stroke engine, the working cycle is completed in two strokes of the piston or one revolution of the crankshaft. This is achieved by carrying out the suction and compression process in one stroke (or more precisely in inward stroke), expansion and exhaust processes in the second stroke (or more precisely in outward stroke). In a four-stroke engine, the working cycle is completed in four-strokes of the piston or two-revolutions of the crankshaft. This is achieved by carrying suction, compression, expansion and exhaust processes in each stroke.

It will be interesting to know that from the thermodynamic point of view, there is no difference between two-stroke and four-stroke cycle engines. The difference is purely mechanical which are as follows :

1. A two stroke cycle engine gives twice the number of power strokes than the four stroke cycle engine at the same engine speed. Theoretically, a two-stroke cycle engine should develop twice power as that of a four-stroke cycle engine. But in actual practice, a two-stroke cycle engine develops 1.7 to 1.8 times (greater value for slow speed engines) the power developed by four-stroke cycle engine of the same dimensions and speed. This is due to lower compression ratio and effect stroke being less than the theoretical stroke.

2. For the same power developed, a two-stroke cycle engine is lighter, less bulky and occupies less floor area. Thus it makes, a two-stroke cycle engine suitable for marine engine other light vehicles.

3. As the number of working strokes in a two-stroke cycle engine are twice than four-stroke cycle engine, so the turning moment of a two-stroke cycle engine is more uniform. So it makes a two-stroke cycle engine to have a lighter flywheel and foundations. This also leads to higher mechanical efficiency of a two-stroke cycle engine.

4. The initial cost of a two-stroke cycle engine is considerably less than a four-stroke cycle engine.

5. The mechanism of a two-stroke cycle engine is much simpler than a four-stroke cycle engine

6. The two-stroke cycle engines are much easier to start.

7. Thermal efficiency of a two-stroke cycle engine is less than that a four-stroke cycle engine because a two-stroke cycle engine has less compression ratio than that of a four-stroke cycle engine

8. Overall efficiency of a two-stroke cycle engine is also less than that of a four-stroke cycle engine because in a two-stroke cycle, inlet and exhaust ports remain open simultaneously for sometime. In spite of careful design, a small quantity of charge is lost from the engine cylinder.

9. In case of a two-stroke cycle engine, the number of power strokes are twice as those of fourstroke cycle engine. Thus the capacity of the cooling system must be higher. Beyond a certain limit, the cooling capacity offers a considerable difficulty. Moreover, there is a greater wear and in a two-stroke cycle engine.

10. The consumption of lubricating oil is large in a twp-stroke cycle engine because of the high operating temperature.

11. The exhaust gases in a two-stroke cycle engine creates noise, because of short time available for their exhaust.

7.2.1. Difference between petrol and diesel engine.

Following points are important for the comparison of petrol engines and diesel engine

Petrol Engines	Diesel Engines
1. A petrol engine draws a mixture of petrol and air during suction stroke.	A diesel engine draws only air during suction stroke.
2. The carburetor is employed to mix air and petrol in the required proportion and to supply it to the engine during suction stroke.	The injector or atomiser is employed to inject fuel at the end of compression stroke.
3. Pressure at the end of compression is about 10 bar.	Pressure at the end of compression is about 35 bar.
4. The charge (i.e. petrol and air mixture) is ignited with the help of spark plug.	The fuel is injected in the form of fine spray. The temperature of the compressed air (about 600°C at a pressure of about 35 bar) is sufficiently able to ignite the fuel.
5. The combustion of fuel takes place approximately at constant volume. In other words, it works on Otto cycle.	The combustion of fuel takes place approximately at constant pressure. In other words, it works on Diesel cycle.
6. A petrol engine has compression ratio approximately from 6 to 10.	A diesel engine has compression ratio approximately from 15 to 25.
7. The starting is easy due to low compression ratio.	The starting is little difficult due to high compression ratio.
8. As the compression ratio is low, the petrol engines are lighter and cheaper.	As the compression ratio is high, the diesel engines are heavier and costlier.
9. The running cost of a petrol engine is high because of the higher cost of petrol.	The running cost of diesel engine is low because of the lower cost of diesel.

Petrol Engines	Diesel Engines
<p>10. The maintenance cost is less.</p> <p>11. The thermal efficiency is upto about 26%.</p> <p>12. Overheating trouble is more due to low thermal efficiency.</p> <p>13. These are high speed engines.</p> <p>14. The petrol engines are generally employed in light duty vehicles such as scooters, motorcycles, cars. These are also used in aeroplanes.</p>	<p>The maintenance cost is more.</p> <p>The thermal efficiency is upto about 40%.</p> <p>Oveheating trouble is less due to high thermal efficiency.</p> <p>These are relatively low speed engines.</p> <p>The diesel engines are generally employed in heavy duty vehicles like buses, bucks, and cars moving machines etc.</p>

ELEMENTS OF MECHANICAL ENGINEERING

CHAPTER -8

HYDROSTATICS

PROPERTIES OF FLUID

a) Density or mass density

#-The **density**, or more precisely, the **volumetric mass density**, of a substance is its mass per unit volume. The symbol most often used for density is ρ (the lower case Greek letter rho). Mathematically, density is defined as mass divided by volume

$$\rho = \frac{m}{V},$$

Where ρ is the density, m is the mass, and V is the volume. In some cases

#-Density of water at S.T.P.(standard temp & pressure)i.e at 0°C (273.15k) and 1 atm pressure(101.325kNm²)

Density of water at 4°C and 1 atm pressure =999.9720kg/m³≈1000kg/m³

Density of water at sea level i.e at 15°C and 1 atm pressure =999.1026kg/m³

b) Specific weight

The **specific weight** is the weight per unit volume of fluid. The symbol of specific weight is ' γ '

Unit of weight density is N/m³

#-weight density of water is 9.81x1000N/m³ at standard atmospheric pressure of 101.325 KN/m² at sea level and temp 15°C .

C) Specific volume

The **specific volume** of fluid is the ratio of the substance's volume to its mass. It is the reciprocal of density and is an intrinsic property of matter:

$$v = \frac{V}{m} = \rho^{-1}$$

Unit of specific volume m³/kg in S.I unit

#-the concept of specific volume is found to be practically more useful in the study of flow of compressible fluid.

d) Specific gravity

Specific gravity is the ratio of specific weight or density of fluid to specific weight or density of the standard fluid. The reference fluid is nearly always water at its densest, (4°C) for liquids and for gases.

Specific gravity is a constant. It is dimensionless and has no unit. It is denoted by the symbol 'S'

$$S = \frac{\text{specific weight or density of liquid}}{\text{specific weight or density of water}}$$

#-Specific weight of a liquid = S x specific weight of water

$$= S \times 9.8 \times 1000 \text{ N/m}^3$$

Density of liquid = S x density of water

Pressure (symbol: p or P) is the ratio of force to the area over which that force is distributed.

Pressure is force per unit area applied in a direction perpendicular to the surface of an object. Gauge pressure (also spelled *gage* pressure) is the pressure relative to the local atmospheric or ambient pressure. Pressure is measured in any unit of force divided by any unit of area. The SI unit of pressure is the newton per meter square, which is called the Pascal (Pa) after the seventeenth-century philosopher and scientist Blaise Pascal. The lbf/square inch (PSI) is the traditional unit of pressure in US/UK customary units. A pressure of 1 Pa approximately equals the pressure exerted by a dollar bill resting flat on a table. Everyday pressures are often stated in kilopascals (1 kPa = 1000 Pa) – 1 kPa is approximately one-seventh of lbf/in².

Pressure measuring instrument

Many techniques have been developed for the measurement of pressure and vacuum. Instruments used to measure pressure are called **pressure gauges** or **vacuum gauges**.

A '**manometer**' is an instrument that uses a column of liquid to measure pressure, although the term is often used nowadays to mean any pressure measuring instrument.

A **vacuum gauge** is used to measure the pressure in a vacuum—which is further divided into two subcategories, high and low vacuum (and sometimes ultra-high vacuum). The applicable pressure range of many of the techniques used to measure vacuums have an overlap. Hence, by combining several different types of gauge, it is possible to measure system pressure continuously from 10 mbar down to 10⁻¹¹ mbar.

Absolute, gauge and differential pressures - zero reference

Everyday pressure measurements, such as for tire pressure, are usually made relative to ambient air pressure. In other cases measurements are made relative to a vacuum or to some other specific reference. When distinguishing between these zero references, the following terms are used:

- **Absolute pressure** is zero-referenced against a perfect vacuum, so it is equal to gauge pressure plus atmospheric pressure.

- **Gauge pressure** is zero-referenced against ambient air pressure, so it is equal to absolute pressure minus atmospheric pressure. Negative signs are usually omitted. To distinguish a negative pressure, the value may be appended with the word "vacuum" or the gauge may be labeled a "vacuum gauge."
- **Differential pressure** is the difference in pressure between two points.

Types of manometer:

1. simple manometer
2. U-tube manometer
3. Differential manometer

1. simple manometer:

A simple manometer is one which consists of a glass tube, whose one end is connected to a point where pressure is to be measured and the other end is open to atmosphere.

Piezometer

Piezometer is one of the simplest forms of manometers. It can be used for measuring moderate pressures of liquids. The setup of piezometer consists of a glass tube, inserted in the wall of a vessel or of a pipe. The tube extends vertically upward to such a height that liquid can freely rise in it without overflowing. The pressure at any point in the liquid is indicated by the height of the liquid in the tube above that point.

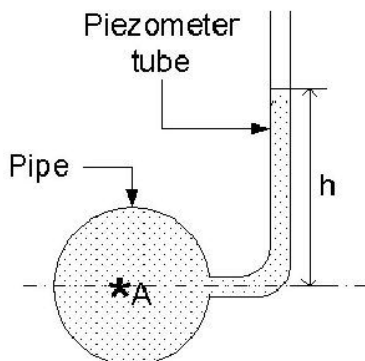

Pressure at point A can be computed by measuring the height to which the liquid rises in the glass tube. The pressure at point A is given by $p = wh$, where w is the specific weight of the liquid.

2. The "U"-Tube Manometer

Using a "U"-Tube enables the pressure of both liquids and gases to be measured with the same instrument. The "U" is connected as in the figure below and filled with a fluid called the *manometric fluid*. The fluid whose pressure is being measured should have a mass density less than that of the manometric fluid and the two fluids should not be able to mix readily - that is, they must be immiscible.

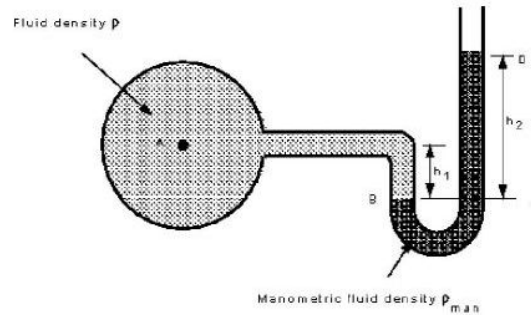

Pressure in a continuous static fluid is the same at any horizontal level so,

pressure at B = pressure at C

$$P_B = P_C$$

For the **left hand arm**

pressure at B = pressure at A + pressure due to height h_1 of fluid being measured

$$P_B = P_A + \rho g h_1$$

For the **right hand arm**

pressure at C = pressure at D + pressure due to height h_2 of manometric fluid

$$P_C = P_{\text{Atmospheric}} + \rho_{\text{man}} g h_2$$

As we are measuring *gauge pressure* we can subtract $P_{\text{Atmospheric}}$ giving

$$P_B = P_C$$

$$P_A = \rho_{\text{man}} g h_2 - \rho g h_1$$

If the fluid being measured is a gas, the density will probably be very low in comparison to the density of the manometric fluid i.e. $\rho_{\text{man}} \gg \rho$. In this case the term $\rho g h_1$ can be neglected, and the gauge pressure given by

$$P_A = \rho_{\text{man}} g h_2$$

Differential U – tube manometer

It is used when difference between two pressures needed and consists of a transparent U-tube containing the fluid of density (ρ) whose pressure is to be measured and an immiscible fluid (m) of higher density (ρ_m).

The limbs are connected to the two points between which the pressure difference ($P_2 - P_1$) is required.

The pressure at level x will be: $P_x = P_1 + \rho g (a+h)$

The pressure at level x will be: $P_x = P_2 + \rho_m g h + \rho g a$

Since $P_x = P_x$ (at same level)

Then $P_1 - P_2 = (\rho_m - \rho) g h$

There is other type of differential U – tube manometer

The configuration A suitable for large pressure differences and requires dense measuring fluid (e.g. mercury), while configuration B for small differences and needs light measuring fluid

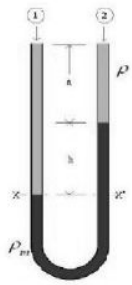

Inverted U- Tube manometer

It is used for measuring *pressure differences in liquids*. The space above the liquid in the manometer is filled with air, Which can be admitted or expelled through the tap A in order to adjust the level of the liquid in the manometer.(figure 3-13)

The pressure at level x will be: $P_x = P_1 - \rho g (a+h)$

The pressure at level x' will be: $P_{x'} = P_2 - \rho_m g h - \rho g a$

Since $P_x = P_{x'}$ (at same level)

Then $P_1 - P_2 = (\rho - \rho_m) gh$

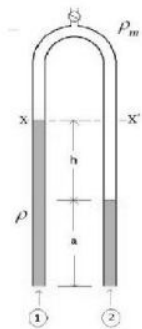

CHAPTER -9

HYDROKINETICS

It is the branch of science concerned with the mechanical behavior and properties of fluids in motion.

Continuity Equation

When a fluid is in motion, it must move in such a way that mass is conserved. To see how mass conservation places restrictions on the velocity field, consider the **steady** flow of fluid through a duct (that is, the inlet and outlet flows do not vary with time). The inflow and outflow are **one-dimensional**, so that the velocity V and density ρ are constant over the area A (figure 14).

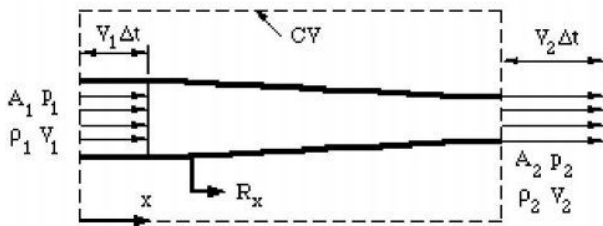

Figure 14. One-dimensional duct showing control volume.

Now we apply the principle of mass conservation. Since there is no flow through the side walls of the duct, what mass comes in over A_1 goes out of A_2 , (the flow is steady so that there is no mass accumulation). Over a short time interval Δt ,

$$\text{volume flow in over } A_1 = A_1 V_1 \Delta t$$

$$\text{volume flow out over } A_2 = A_2 V_2 \Delta t$$

Therefore

$$\text{mass in over } A = \rho A_1 V_1 \Delta t$$

$$\text{mass out over } A = \rho A_2 V_2 \Delta t$$

$$\text{So: } \boxed{\rho A_1 V_1 = \rho A_2 V_2}$$

This is a statement of the principle of mass conservation for a steady, one-dimensional flow, with one inlet and one outlet. This equation is called the **continuity equation** for steady one-dimensional flow. For a steady flow through a control volume with many inlets and outlets, the net mass flow must be zero, where inflows are negative and outflows are positive.

Streamlines and Streamtubes

A **streamline** is a line that is tangential to the instantaneous velocity direction (velocity is a vector, and it has a magnitude and a direction). To visualize this in a flow, we could imagine the motion of a small marked element of fluid. For example, we could mark a drop of water with fluorescent dye and illuminate it using a laser so that it fluoresces. If we took a short exposure photograph as the drop moves according to the local velocity field (where the exposure needs to be short compared to the time it takes for the velocity to change appreciably), we would see a

VARIOUS ENERGIES OF FLUID;

There are three types of energies or head as follows

1. **Pressure energy or pressure head**- is the energy possessed by a liquid particle by virtue of its existing pressure. Pressure energy or pressure head is denoted by $p/\rho g$.

2. **Kinetic energy**- It is the energy possessed by a liquid particle by virtue of its motion or velocity. K.E is also known as kinetic head or velocity head. Kinetic energy or kinetic head is measured as $v^2/2g$

3. **Potential energy**- It is the energy possessed by a liquid particle by virtue of its position with respect to a datum. Potential energy or potential head is denoted by z .

TOTAL ENERGY- Total energy of a liquid particle in motion is the sum of its pressure energy , kinetic energy and potential energy.

$$\text{Total energy head } H = p/\rho g + v^2/2g + z$$

STATE AND PROVE BERNOULLI'S EQUATION:-

Bernoulli's equation states that , "In an ideal incompressible fluid when the flow is steady and continuous the sum of pressure energy, kinetic energy and potential energy is constant along a stream line. Mathematically $p/\rho g + v^2/2g + z$ is constant.

Where $p/\rho g$ =pressure energy

$v^2/2g$ =kinetic energy

z =datum energy

Proof:-

Consider an ideal incompressible liquid flowing through a non-uniform pipe as shown in the figure.

Let us consider two sections 1-1 & 2-2 and assume that the pipe is running full and there is continuity of flow between the two sections.

Let p_1 =pressure at 1-1

V_1 =velocity of liquid at 1-1

Z_1 =height of 1-1 above the datum

A_1 =area of pipe at 1-1

And p_2, v_2, z_2, a_2 are corresponding values at 2-2.

Let the liquid between two sections 1-1 & 2-2 move to 1'-1' & 2'-2' through very small length dl_1 & dl_2 as shown in the figure.

This movement of liquid between 1-1 & 2-2 is equivalent to the movement of the liquid between 1-1 and between 1'-1' and between 2-2 & between 2'-2'.

Let W =weight of the liquid between 1-1 & 1'-1'

As the flow is continuous $W = \rho g A_1 \times dl_1 = \rho g A_2 \times dl_2$

$$\text{Or } A_1 \times dl_1 = W / \rho g$$

$$\text{Or } A_2 \times dl_2 = W / \rho g$$

$$\text{Or } A_1 \times dl_1 = A_2 \times dl_2$$

Work done by pressure force at 1-1 moving the liquid to 1'-1' = force \times distance = $p_1 A_1 \times dl_1$

Similarly work done by the pressure force at 2-2 in moving the liquid to 2'-2' = $p_2 A_2 \times dl_2$

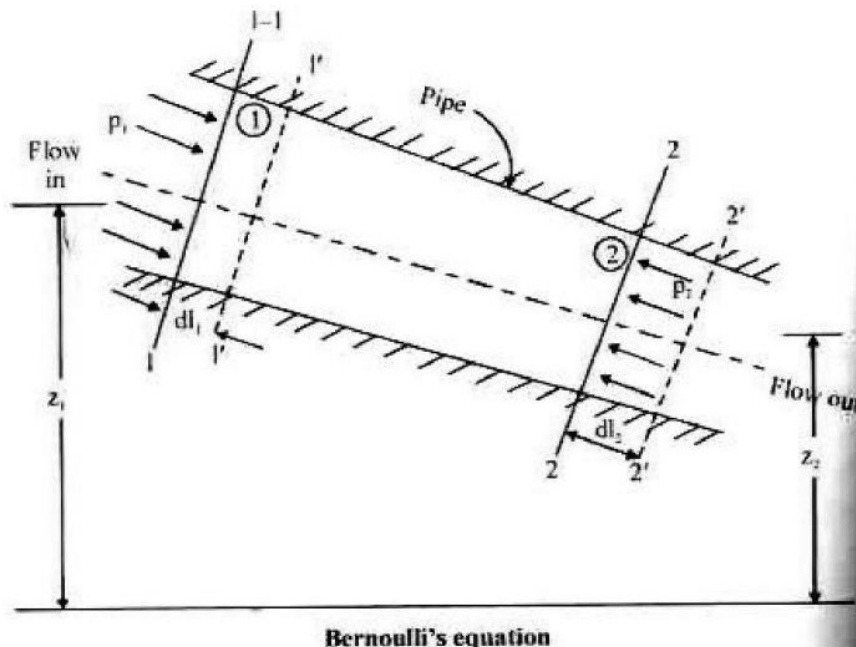

Total work done by the pressure = $p_1 A_1 \times dl_1 - p_2 A_2 \times dl_2$ ($A_1 \times dl_1 = A_2 \times dl_2$)

$$=A_1 \times dl_1 (p_1 - p_2)$$

$$=w/\rho g (p_1 - p_2)$$

Loss of potential energy $=w(z_1 - z_2)$

Gain in kinetic energy $=w(v_2^2/2g - v_1^2/2g)$

$$=w/2g(v_2^2 - v_1^2)$$

Also loss of potential energy + work done by pressure = gain in kinetic energy

Since $w(z_1 - z_2) + w/\rho g (p_1 - p_2) = W/2g(v_2^2 - v_1^2)$

Or $z_1 - z_2 + (p_1/\rho g - p_2/\rho g) = (v_2^2/2g - v_1^2/2g)$

Or $p_1/\rho g + v_1^2/2g + z_1 = p_2/\rho g + v_2^2/2g + z_2$

This proves Bernoulli's Equation.

CHAPTER-10

HYDRAULIC DEVICE AND PNEUMATICS

Hydraulic intensifier

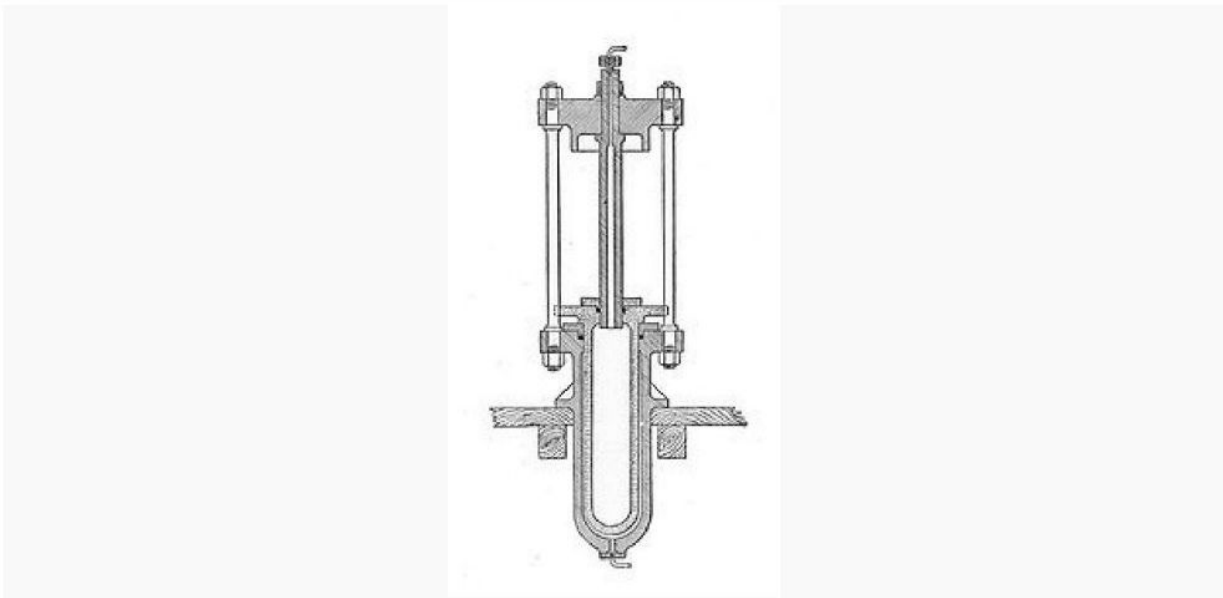

A **hydraulic intensifier** is a hydraulic machine for transforming hydraulic power at low pressure into a reduced volume at higher pressure.

Operation

Such a machine may be constructed by mechanically connecting two pistons, each working in a separate cylinder of a different diameter. As the pistons are mechanically linked, their force and stroke length are the same. If the diameters are different, the hydraulic pressure in each cylinder will vary in the same ratio as their areas: the smaller piston giving rise to a higher pressure. As the pressure is inversely proportional to the area, it will be inversely proportional to the *square* of the diameter.

The working volume of the intensifier is limited by the stroke of the piston. This in turn limits the amount of work that may be done by one stroke of the intensifier. These are not reciprocating machines (i.e. continually running multi-stroke machines) and so their entire work must be carried out by a single stroke. This limits their usefulness somewhat, to machines that can accomplish their task within a single stroke. They are often used where a powerful hydraulic jack is required, but there is insufficient space to fit the cylinder size that would normally be required, for the lifting force necessary and with the available system pressure. Using an intensifier, mounted outside the jack, allows a higher pressure to be obtained and thus a smaller cylinder used for the same lift force. Intensifiers are also used as part of machines such as hydraulic presses, where a higher pressure is required and a suitable supply is already available.

Some small intensifiers have been constructed with a stepped piston. This is a double-ended piston, of two different diameters, each end working in a different cylinder. This construction is simple and compact, requiring an overall length little more than twice the stroke. It is also still necessary to provide two seals, one for each piston, and to vent the area between them. A leak of pressure into

the volume between the pistons would transform the machine into an effective single piston with equal area on each side, thus defeating the intensifier effect.

A mechanically compact and popular form of intensifier is the concentric cylinder form, as illustrated. In this design, one piston and cylinder are reversed: instead of the large diameter piston driving a smaller piston, it instead drives a smaller moving cylinder that fits over a fixed piston. This design is compact, and again may be made in little over twice the stroke. It has the great advantage though that there is no "piston rod" and the effective distance between the two pistons is short, thus permitting a much lighter construction without risk of bending or jamming.

Hydraulic accumulator

A **hydraulic accumulator** is a pressure storage reservoir in which a non-compressible hydraulic fluid is held under pressure by an external source. The external source can be aspring, a raised weight, or a compressed gas. An accumulator enables a hydraulic system to cope with extremes of demand using a less powerful pump, to respond more quickly to a temporary demand, and to smooth out pulsations. It is a type of energy storage device.

Compressed gas accumulators, also called hydro-pneumatic accumulators, are by far the most common type.

Functioning of an accumulator

In modern, often mobile, hydraulic systems the preferred item is a gas charged accumulator, but simple systems may be spring-loaded. There may be more than one accumulator in a system. The exact type and placement of each may be a compromise due to its effects and the costs of manufacture.

An accumulator is placed close to the pump with a non-return valve preventing flow back to the pump. In the case of piston-type pumps this accumulator is placed in the ideal location to absorb pulsations of energy from the multi-piston pump. It also helps protect the system from fluid hammer. This protects system components, particularly pipework, from both potentially destructive forces.

An additional benefit is the additional energy that can be stored while the pump is subject to low demand. The designer can use a smaller-capacity pump. The large excursions of system components, such as landing gear on a large aircraft, that require a considerable volume of fluid can also benefit from one or more accumulators. These are often placed close to the demand to help overcome restrictions and drag from long pipework runs. The outflow of energy from a discharging accumulator is much greater, for a short time, than even large pumps could generate.

An accumulator can maintain the pressure in a system for periods when there are slight leaks without the pump being cycled on and off constantly. When temperature changes cause pressure excursions the accumulator helps absorb them. Its size helps absorb fluid that might otherwise be locked in a small fixed system with no room for expansion due to valve arrangement.

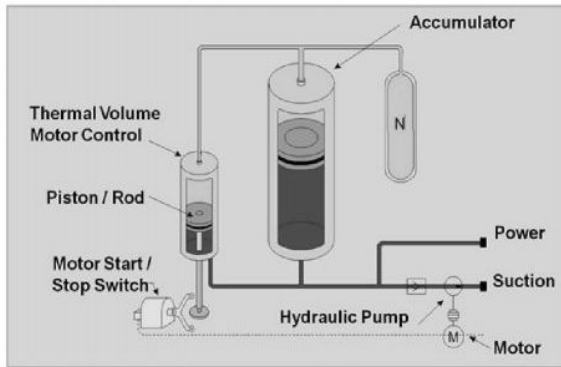

Direct Acting Hydraulic Lift:

CONSTRUCTION DETAILS: Components of direct acting hydraulic lift:

- Fixed cylinder: It is fixed with the wall of the floor, where the sliding ram reciprocate when we apply the pressure.
- Cage: It is fitted on the top of the sliding ram where the load is placed (i.e. lifted load).
- Sliding ram: It is fitted in the fixed cylinder which is reciprocate (upward or downward direction) when we applied the pressure (i.e. reaches the floor wise.)

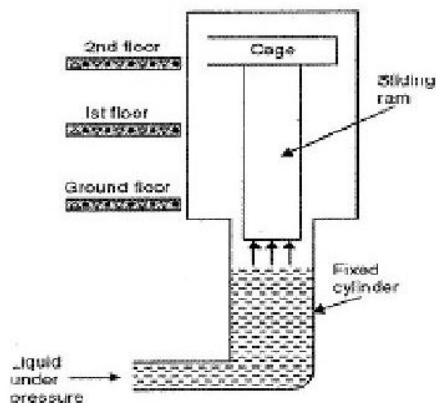

When fluid under pressure is forced into the cylinder, the ram gets a push upward. The platform carries loads or passengers and moves between the guides. At required height, it can be made to stay in level with each floor so that the good or passengers can be transferred.

In direct acting hydraulic lift, stroke of the ram is equal to the lift of the cage.

SUSPENDED HYDRAULIC LIFT

CONSTRUCTION DETAILS:

Cage: It is fitted on the top of the sliding ram where the load is placed (i.e. lifted load).

Wire rope: It connects the cage to pulley.

Sliding ram: It is fitted in the fixed cylinder which is reciprocate (upward or downward direction) when we applied the pressure (i.e. reaches the floor wise)

Pulleys: pulleys are connected to the sliding ram and fixed cylinder; where one pulley is fixed and other pulley is movable.

Hydraulic jigger: It consists of a moving ram which slides inside a fixed hydraulic cylinder.

Fixed cylinder:- It is fixed with the wall of the floor, where the sliding ram reciprocate when we apply the pressure.

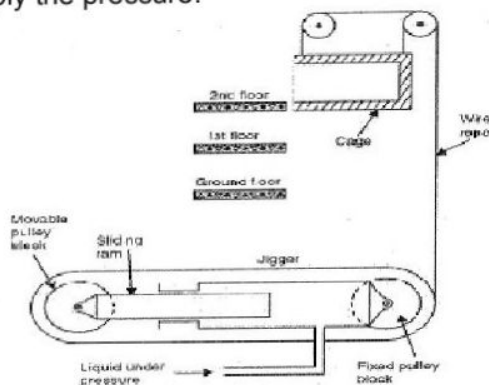

WORKING OF SUSPENDED HYDRAULIC LIFT

When fluid under pressure is forced into the cylinder, the ram gets reciprocate to the movable pulleys. With the help of arrangement of hydraulic jigger; pulley can rotate; with the help of wire rope the cage is maintain there pressure force with there floor. At required height, it can be made to stay in level with each floor so that the good or passengers can be transferred.

Working period of the lift is ratio of the height of lift to the velocity of lift.

Idle period of lift is the difference of the total time for one operation and the working period of the lift.

Hydraulic ram

This article is about the water pump. For the vehicle extraction tool, see [Hydraulic rescue tools](#). For the piston-based actuator, see [hydraulic cylinder](#).

A **hydraulic ram**, or **hydram**, is a [cyclic water pump](#) powered by [hydropower](#). It takes in water at one "[hydraulic head](#)" (pressure) and flow rate, and outputs water at a higher hydraulic head

and lower flow rate. The device uses the water hammer effect to develop pressure that allows a portion of the input water that powers the pump to be lifted to a point higher than where the water originally started. The hydraulic ram is sometimes used in remote areas, where there is both a source of low-head hydropower and a need for pumping water to a destination higher in elevation than the source. In this situation, the ram is often useful, since it requires no outside source of power other than the kinetic energy of flowing water.

The working principle of hydraulic ram is to use surge pressure which is produced after flow blocked and ten times higher than normal to lift water.

Before working, waste valve stays open under the action of magnet spring while delivery valve keep closed under the action of magnet spring and its gravity. It can work automatically when we control the waste valve to repeat the operation procedures of open and close. After that, water with different levels will flow out through water drive pipe and opened waste valve, and running water will drive the waste valve to close when the pressure inside the waste valve surpass that in magnet spring, and that is the water hammer. At the moment, water pressure rapidly increases and enforces the delivery valve to open, and some water flows into air chamber. Pressure inside the waste valve drops promptly and the waste valve reopens under the action of magnet spring and negative pressure. While delivery valve closes again by the action of self gravity and the pressure in magnet spring and air chamber. By the action of water flow, movements foregoing repeat automatically. And water will flow out through the delivery pipe when the pressure in air chamber exceeds that in lifting pipes.

